



F. Remington, *Buffalo Runners - Big Horn Basin* (detail) 1909

The First Americans

An Educator's Guide

Mary Burke, Sid Richardson Museum, with Diane McClure, Art Specialist
Design by Laura Fenley, Sid Richardson Museum Intern
© 2004 Sid Richardson Museum, Third Edition © 2009

The First Americans

Page numbers for each section are listed below.

Online version – click on the content title below to link directly to the first page of each section.

For an overview of the artworks included in this booklet, see Select a Lesson – Image List, page 30.

Contents

Introduction to The First Americans	4
Sid W. Richardson	6
The Museum	10
Frederic S. Remington	12
Charles M. Russell	14
Timeline (Artists, Texas, U.S. History)	16
Select a Lesson – Image List	30
Lesson Plans	32
Student Activities	58
Teacher Resources	66



The First Americans
Sid Richardson Museum

About the Educator's Guide

This Educator's Guide is a resource for viewing and interpreting works of art from the Sid Richardson Museum in the classroom environment. The images included in the Guide have been selected to serve as a point of departure for an examination of the diversity of Native American cultures.

The background materials (timelines, biographies, bibliography and resources) are appropriate for educators of all levels. The Lesson Plans are designed for elementary teachers and satisfy several state-mandated goals for Fine Arts, Language Arts and Social Studies, but can be adapted for other grade levels and disciplines. Written in the form of a dialogue, the Lesson Plans are designed to aid students in their exploration of the works of art.

The Guide includes:

- Sid W. Richardson – a biography, including a timeline of the life of oilman, philanthropist and collector Sid W. Richardson
- The Museum – operating hours, location, and contact information
- The Artists – biographies of artists Frederic Remington and Charles Russell, with a timeline of events in the artists' lives, as well as events in Texas and American history

- Lesson Plans – color images, each with a suggested dialogue containing questions to direct classroom discussion and engage students in their exploration of the artworks, background information about the artists and the works of art, vocabulary, and suggestions for extension activities
- Student Activities – activities that can be used to complement classroom discussion about these (or other) artworks
- Bibliography – sources used in the development of this Guide and suggestions for further reading on the artists or topics
- Teacher Resources – related historical background, strategies for making personal and meaningful connections with works of art, and recommended web resources

This Educator's Guide is designed to help you and your students explore the artworks in the Sid Richardson Museum. For further information about education resources at the Museum, contact the Museum's education department at education@sidrichardsonmuseum.org or 817.332.6554.



The First Americans

Introduction

The images included in *The First Americans* offer viewers a glimpse into the ambiguity of late 19th century attitudes toward the Native American.

During the course of the century, artists' depiction of the American Indian underwent dramatic transformations. Viewed from the lens of their own culture, nineteenth century artists portrayed the American Indian in disparate ways.

Initially, the Native American was often depicted as a noble savage, a man of intuition and emotion, set in an earthly paradise. As the white man pushed further west, that image changed to become one of a fierce warrior, an obstacle that stood in the way of the white man's peaceful progress. Later in the century, as much of the Native American way of life was destroyed and the Native American threat was diminished, the American Indian was sometimes pictured as a doomed relic of the past, proud in defeat.

Frederic Remington, (1861 - 1909), and Charles Russell, (1864 - 1926), were born at a time when much of the American Indian way of life was swiftly vanishing or had already disappeared. They, as artists before them, recorded their impressions of Native American life from the viewpoint of their life experiences.

Russell called the Native American "the onley [sic] real American," and spoke out publicly in support of their rights. An adopted member of the Blood Indians, earning the name Ah-Was-Cous, or antelope, Russell's paintings may reflect



C. Russell, *The Marriage Ceremony* 1894

the experience of having lived a short time with the Blackfoot Indians - scenes illustrating the roles of men and women in *Returning to Camp*, courtship in *The Marriage Ceremony*, stages of life in *Three Generations*, and the Plains Indians perilous pursuit of buffalo in *Wounded*.

Remington depicted the Native Americans hunt for buffalo, too, in the crackling, crisp air of the wide open west in *The Buffalo Runners - Big Horn Basin*. He sensitively portrayed the hardship of a Native American in *The Luckless Hunter*. Remington, the son of a Civil War hero, also painted dramatic scenes of conflict between the white man and the Native American, with apparent sympathy towards the white man, in *Captured*.

The literature Remington wrote for periodicals mirror the conflicting sentiments of the times. Consider these contradictory accounts of Native Americans, as evidenced



The First Americans
Sid Richardson Museum

in two quotes, the first from the January 31, 1891 issue of *Harper's Weekly*, and the latter from the December 16, 1899 issue of *Collier's Weekly*.

I sat near the fire and looked intently at one human brute opposite, a perfect animal, so far as I could see. Never was there a face so replete with human depravity, stolid, ferocious, arrogant...ghost shirt, war-paint, feathers, and arms.

They were fighting for their land - they fought to the death - they never gave quarter, and they never asked it. There was a nobility of purpose about their resistance which commends itself now that it is passed.



F. Remington, *Captured* 1899

The visual documents of Remington and Russell offer a glimpse into the social order, language, symbols, and dress of the Native American of the past. Do these images depict the lifestyle of today's Native Americans? How do your students respond to these images? Their vantage point provides yet again another lens with which to view these works of art.

These images provide an entry into an understanding of the way these two artists responded to a particular time and place, and offer students an opportunity to make connections with the ideas and values of their own culture.



F. Remington, *The Luckless Hunter* 1909



Sid W. Richardson

Untitled photo of Sid Richardson on a horse

Courtesy, Fort Worth Star-Telegram Photography Collection, Special Collections, The University of Texas at Arlington Libraries, Arlington, Texas



The Sid Richardson Museum is a permanent exhibit of extraordinary paintings by the premier artists of the American West, Frederic Remington and Charles M. Russell, and their contemporaries. The works, reflecting both the art and reality of the American West, are the legacy of the late oilman and philanthropist, Sid Williams Richardson.

Richardson was born to modest means in Athens, Texas in 1891. The son of a peach farmer, he received his early

education in the schools that his hometown offered. He attended both Hardin Simmons and Baylor University from 1910 - 1912, but found it necessary to leave school and enter the business world when he could no longer afford the tuition.

Richardson's first job was that of an oil scout, then later an oil well supply salesman and lease purchaser. Subsequently, he formed a partnership in the oil business with his friend, Clint Murchison, amassing a fortune in 1919 - 1920. In the 1920s, Richardson's fortunes rose and fell with sharp oil market fluctuations. Then, in the early 30s, with a small investment and support from friends, he struck it big in the Keystone Field in West Texas, turning his oil business into a booming success.

With his fortune established, Mr. Sid, as his friends knew him, was able to indulge his interest in cattle and horses, acquiring large ranching operations both in Texas and Oklahoma. A lover of fine animals, Richardson raised registered Quarter Horses and Santa Gertrudis cattle on his ranches. His favorite riding horse was Dude, a big paint that came to him at the call of his name.

A man of mystery, who rarely spoke to reporters and shunned publicity, Richardson once explained his philosophy by saying, "You ain't learning nothing when you're talking." Though he did not publicize his generosity, he made large contributions to churches, civic groups and libraries in Texas.

In 1942, Sid Richardson turned his attention to collecting the works of the artists whom he felt best portrayed the West he knew and loved. That year, he asked Bertram Newhouse, president of the Newhouse Galleries in New York City, to find western pictures for his collection. Between 1942 and 1950, Mr. Newhouse helped him acquire the majority of the paintings now seen at the Sid Richardson Museum.



The First Americans
Sid Richardson Museum

In 1947, Sid Richardson established a foundation for the purpose of supporting organizations that served the people of Texas. Throughout the years, the board of directors and staff have sought to fulfill his vision by providing grants primarily in the areas of education, health, human services and the arts and humanities.

The late Texas Governor John Connally, Richardson's attorney during the 1950s and a close friend, remembered Richardson as "a man of great courage, yet soft spoken, kind, sentimental and loyal to everyone who befriended him." He recognized Sid Richardson as a man who loved to create and build who would accept challenges and pursue them:

He was in no sense extravagant or flamboyant, but rather a plain spoken man who got along with people of all walks of life. He was very much at home with cowboys in a country cafe, but also comfortable in fine New York restaurants.

Mr. Richardson, a life-long bachelor, was known for his ability to condense complicated situations into simple "horse sense" that endeared him to presidents and business executives. When asked to describe his own business philosophy, he said, "I guess my philosophy of business life is: Don't be in too big of a hurry, don't get excited and don't lose your sense of humor."

His reputation as a tireless dealmaker stayed with him to the end of his life. After a full day's work, he died quietly in his sleep on September 30, 1959, at his home on San Jose Island off the coast of Rockport, Texas. He was buried in the family plot near Athens, Texas. Richardson continues to have an impact on his native state through the diverse philanthropic programs of the Sid W. Richardson Foundation.

The paintings Mr. Richardson loved so well are now displayed in the Sid Richardson Museum, which opened in November of 1982. In 2006, after a yearlong renovation, the Museum reopened with an elegant new facade, enlarged museum store, and expanded exhibition spaces. The Museum and Foundation are located in downtown Fort Worth in historic Sundance Square. Foundation trustees chose the site both for its convenience to downtown visitors and workers, and for the historic atmosphere of the area. As the museum has become more widely known, attendance has grown to over 50,000 annually, with visitors coming from all 50 states and around the world.

Following Sid Richardson's philosophy of helping others, this free museum offers educational tours for adults and children, as well as outreach programs to local schools and community groups.



Untitled photograph of Sid Richardson (seated), Amon Carter (left) and Dwight Eisenhower (right)
 Courtesy, Fort Worth Star-Telegram Photography Collection, Special Collections, The University of Texas at Arlington Libraries, Arlington, Texas



Sid W. Richardson Timeline

Untitled portrait of Sid Richardson

Courtesy, Fort Worth Star-Telegram Photography Collection, Special Collections, The University of Texas at Arlington Libraries, Arlington, Texas



1891 - Richardson is born on April 25 in Athens, Texas.

1899 - Has first business deal with his father.

Sid Richardson posing for Peter Hurd's Mural of the Oil Industry at Texas Tech University in Lubbock, TX

Courtesy, Fort Worth Star-Telegram Photography Collection, Special Collections, The University of Texas at Arlington Libraries, Arlington, Texas



1906 - Suffers wagon accident, fractures leg.

1907 - Fired from Athens, TX cotton compress company.

1908 - Makes successful cattle trade in Ruston, Louisiana.

1910 - Attends Baylor University in Waco, TX.

1911 - Attends Simmons College in Abilene, TX.

1918 - Travels to West Central TX to work for Texas Company as a scout.

1919 - Strikes oil with Clint Murchison near bank of Red River between TX and OK. Becomes independent oil driller. Accumulates \$100,000.

1921 - Depressed oil prices ruin Richardson and Murchison.

| 1890 | 1895 | 1900 | 1905 | 1910 | 1915 | 1920 |



The First Americans
Sid Richardson Museum

- 1929** - Rebounding, Richardson has producing wells in Texas counties of Ward and Winkler.
- 1930** - The big East Texas oil fields are tapped and oil prices plunge again.
- 1931** - Richardson drills in Winkler County in the B.S. Edwards lease.
- 1932** - Starts again with \$40 from sister, wildcats in West Texas. Richardson's first field is purchased in Ward and Winkler counties.
- 1933** - Joins in partnership with nephew Perry Bass, buys lease from Pure Oil Company. Drills in Keystone field, Winkler County, TX; major oil strike.
- 1934** - Buys home in Monahans, TX.
- 1935** - Buys San Jose Island off TX coast.
- 1936** - Buys San Jose Island off TX coast.
- 1937** - Hosts President Franklin D. Roosevelt on San Jose Island. Brings in Slaughter field, TX.
- 1938** - Fort Worth Club two-room suite becomes Richardson's Fort Worth home.
- 1939** - Drills successfully in Louisiana.
- 1940** - Begins breeding program to develop hardy strain of cattle which would thrive on San Jose Island.
- Buys and breeds Brahman and Shorthorn cattle, builds up herd of half-blood animals that later serve as foundation for Santa Gertrudis grading up program.
- Has 33 producing wells in Keystone field, 7 in Slaughter, 38 in South Ward, and 47 in Scarborough, all Texas fields.
- 1941** - Becomes petroleum advisor to President Roosevelt.
- 1942** - Begins buying paintings, including *The Courier du Bois and the Savage*, *In A Stiff Current*, *The Forty-niners*, *Attack on the Herd*, *Deer in Forest*, *Nai-U-Chi: Chief of the Bow*, *Zuni 1895*.
- 1947** - Creates the Sid W. Richardson Foundation.
- Buys refinery in Texas City, TX.
- Meets Eisenhower for second time when Eisenhower visits Fort Worth for dedication of Will Roger's statue, meeting seals their friendship.
- Acquires first Santa Gertrudis bulls from King Ranch in Kingsville, TX and moves them to San Jose Island.
- 1948** - Buys carbon black plant outside of Odessa, TX. Forms Sid Richardson Carbon and Gasoline Co.
- Moves 6 cows and 5 Longhorn calves to Fort Griffin State Park, TX.
- 1949** - The Eisenhowers vacation on Richardson's San Jose Island Ranch.
- 1952** - Travels to Paris, France to persuade General Eisenhower to run for presidency.
- 1953** - Richardson becomes one of the founding members of Fort Worth Petroleum Club.
- 1954** - Richardson and Murchison buy New York Central Railroad.
- Look Magazine* features Richardson in article, "The Case of the Billionaire Bachelor."
- With Murchison, buys Del Mar race track in California.
- Peter Hurd mural at Texas Technological College, depicted history of Lubbock and South Plains, TX is dedicated; mural features likeness of Sid, representing oil industry.
- 1955** - Elected president of Fort Worth Club.
- 1957** - Cited as one of the 10 wealthiest men in America in *Ladies Home Journal* article.
- Fortune Magazine* lists Richardson as one of the nation's wealthiest.
- 1959** - Pledges \$100,000 to building of First Baptist Church of Athens, in memory of his mother.
- Richardson dies on September 30, San Jose Island, TX.

| 1925 | 1930 | 1935 | 1940 | 1945 | 1950 | 1955 | 1960



The Museum



About the Sid Richardson Museum

The Sid Richardson Museum displays paintings by Frederic Remington, Charles M. Russell, and other late nineteenth century artists who shaped the public's perception of the American West. The works, reflecting both the art and reality of the West, were acquired by oilman and philanthropist Sid W. Richardson from 1942 until his death in 1959.

Originally opened in 1982, and renovated in 2006, the Museum is housed in historic Sundance Square, an area of restored late nineteenth century buildings in downtown Fort Worth.

The Sid Richardson Museum is just minutes away from major interstate highways and within easy walking distance from downtown hotels.

The Museum Store offers bronze reproductions, prints on canvas, prints, books, and postcards. A variety of gift items are also available including CDs, tapes, jewelry, puzzles, and handmade lariat baskets. Write, call or email for a free color catalog.

Admission to the Museum is free.



The First Americans
Sid Richardson Museum



HOURS:

Monday - Thursday 9 a.m. to 5 p.m.
Friday - Saturday 9 a.m. to 8 p.m.
Sunday 12 p.m. to 5 p.m.

Closed major holidays

WEBSITE: www.sidrichardsonmuseum.org

TOLL FREE: 888.332.6554

EMAIL: info@sidrichardsonmuseum.org

EDUCATION DEPARTMENT

EMAIL: education@sidrichardsonmuseum.org

PHONE: 817.332.6554



Frederic S. Remington



Untitled photo of Remington at his easel at Fort Robinson
Photo courtesy Frederic Remington Art Museum, Ogdensburg, NY.

During a career that spanned less than twenty-five years, Frederic Remington produced a huge body of work - illustration, painting, sculpture, fiction and non-fiction - the vast majority of it centered on the West. His influence in shaping the West of the popular imagination cannot be overstated.

Remington was born in Canton, in northern New York on October 4, 1861. His boyhood fostered a lifelong love of horses and the outdoors. His father's tales of action as a cavalry officer in the Civil War inspired a passion for things military that found a western focus with the Battle of the Little Bighorn in 1876. At fourteen, he was smitten with the urge to go see the West.

As a member of a prominent family, Remington was expected to graduate from college, prepared for a career in business, but spent only a year and a half at Yale University playing football and studying art. After his father's death, he traveled to Montana in 1881, and experienced his first impression of the West.

In 1883, he moved to Kansas where he made an unsuccessful attempt at sheep ranching. The year he spent there was the only time he actually made the West his home, although he made many trips out West and occasionally accompanied the U.S. Cavalry on patrol along the Southwest frontier.



The First Americans
Sid Richardson Museum

Remington's paintings were tributes to the Wild West of fantasy. They drew on the artist's experiences for a sense of place and authentic details, but on his imagination for subject matter. Able to seamlessly fuse observation and imagination, his contemporaries assumed he had witnessed what he portrayed.

Remington had been exhibiting in major art shows since 1888, and was seeking recognition as not just an illustrator, but also an artist in the recognized sense of the term. He made the breakthrough he was seeking in 1895 when he turned to sculpting, which he excelled at and which earned him the critical respect that he strived for. He completed twenty-two sculptures, many which became the defining masterpieces of the Western art tradition.

By 1900, Remington returned to painting and he began to experiment with Impressionism. His technique evolved dramatically the last five years of his life as he rejected the crisp linear illustrator style to concentrate on mood, color and light - sunlight, moonlight, and firelight. His later oils are consistent with his conclusion that his West was dead; he painted impressionistic scenes in which the West, now entirely confined to memory, was invested with a poetry and mystery the present could not touch. He died at age 48, a victim of appendicitis.

Untitled photo of Remington in his New Rochelle, NY studio, 1905
Photo courtesy Frederic Remington Art Museum, Ogdensburg, NY.



Frederic Remington



Charles M. Russell

Like Frederic Remington, Charles M. Russell was born to moderate wealth. A native of St. Louis, Missouri, Russell first came to Montana as a boy of 16 with a dream of becoming a real cowboy. He was so captivated with the West, he chose to stay and fulfill his childhood fantasy.

During those first years, Russell received encouragement from Jake Hoover, a mountain man who befriended him and took him under his wing. Hoover often shared his cabin with the young Charlie, sometimes providing food and shelter for months at a time. This friendship allowed Russell to experience the ways of the frontier life he would later portray so vividly in his paintings.

In 1882 Charlie landed a job as a wrangler on a cattle drive.

He wrangled for eleven years; while he was not known for being a good roper or rider, Russell established a local reputation as the affable cowboy who loved to draw and knew how to tell a great story. As a self-taught artist, his sketches were crude but reflected an observant eye, a feel for animal and human anatomy, a sense of humor and a flair for portraying action - all hallmarks of Russell's mature art.

Throughout his years on the range, he witnessed the changing of the West. He saw the bitter winter of 1886 - 87 end the cattleman's dominion on the northern plains. The days of free grass and unfenced range were ending and, for Russell, the cowboy life was over by 1893.

Prior to his marriage to Nancy Cooper, in 1896, only a few works had been reproduced nationally. Russell was unsure of his ability to earn a living with his art, but Nancy recognized his talent and promise, and provided the

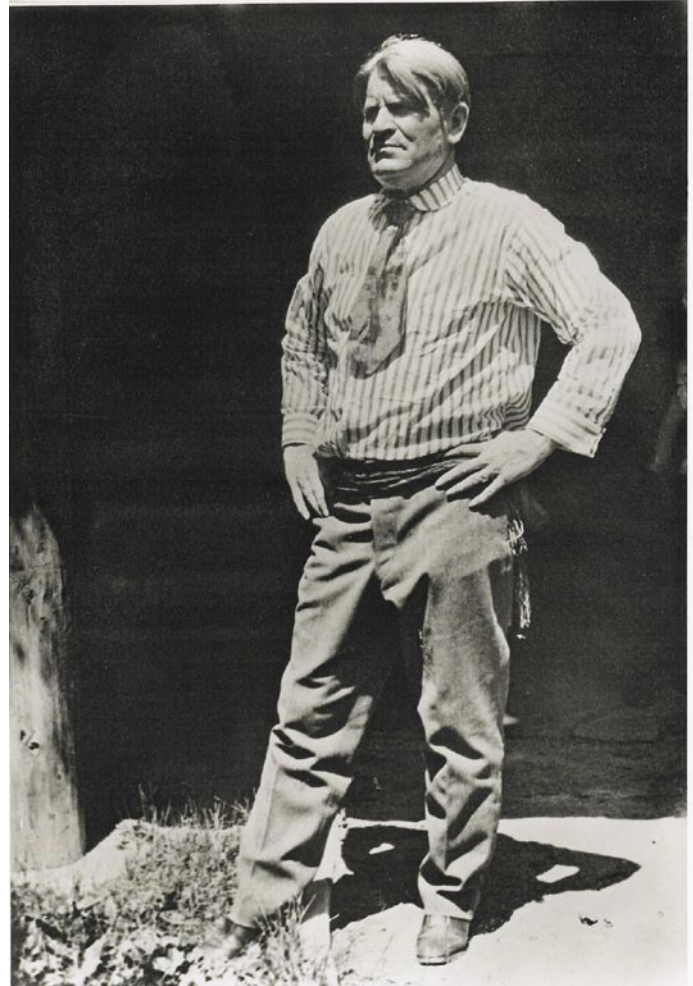
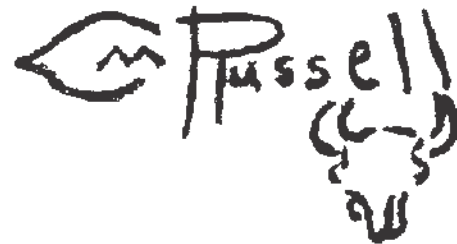

Photo attributed to North D. Stark, *Untitled photograph of Charles Russell*
© Sid Richardson Museum



The First Americans
Sid Richardson Museum

business sense and drive that eventually made him one of America's most popular artists.

Success did not come easily for the Russells. Montana offered few opportunities for art sales, which eventually led them to New York, where contact was established with other artists interested in Western themes. At the time Remington was withdrawing from illustration to concentrate on painting, Russell secured illustrating assignments and gained exposure through exhibitions and press coverage.

His emergence in the art world came in 1911 with a one-man show at a New York gallery, followed three years later by a London exhibition.

Charlie felt deeply the passing of the West, the most evident theme of his art. He was haunted by youthful fantasies, memories of what once was and by the evidence of change that surrounded him as an everyday reality. His work reflected the public demand for authenticity, but also the soul of a romantic.



Photo attributed to North D. Stark, *Charles Marion Russell in his studio with 1914 painting "When The Land Belonged to God"*
© Sid Richardson Museum



Artist Timeline

F.S. REMINGTON

On October 4, Frederic Sackrider Remington is born in Canton, New York to Seth Pierre and Clara Sackrider Remington.

U.S. & TEXAS

Texas secedes from the Union and joins the Confederacy in the Civil War.

First transcontinental telegraph line is completed, putting the Pony Express out of business.

1861

President Lincoln signs Homestead Act, giving settlers 160-acre parcels of land for free once they have settled 5 years.

Lincoln signs Pacific Railway Act, providing financing for a transcontinental railroad.

1862

Painter Albert Bierstadt goes to Yosemite Valley.

Lincoln issues Emancipation Proclamation, freeing slaves in seceding states.

1863

George Pullman begins building the first railroad car designed for sleeping.

1864

Civil War Ends.

Lincoln is assassinated by John Wilkes Booth.

Thirteenth Amendment is ratified. Slavery is abolished.

Texas slaves freed on June 19.

1865

C.M. RUSSELL

On March 19, Charles Marion Russell is born in St. Louis, Missouri to Charles Silas and Mary Elizabeth Meade Russell.



The First Americans
Sid Richardson Museum

F.S. REMINGTON

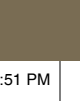

The Artists

U.S. & TEXAS

C.M. RUSSELL

<p>Civil Rights Bill grants full citizenship to all citizens born on U.S. soil, including Native Americans.</p> <p>Transatlantic cable is laid, linking U.S. to Europe.</p> <p>Goodnight-Loving and Chisholm Trails open.</p> <p>1866</p>	<p>Congress ratifies treaty to buy Alaska from Russia.</p> <p>William "Buffalo Bill" Cody is hired by Kansas-Pacific Railroad to kill buffalo that block train travel.</p> <p>Great cattle drives from Texas to Abilene, Kansas begin.</p> <p>1867</p>	<p>1868</p>	<p>15th Amendment gives black males the right to vote.</p> <p>James Oliver patents chilled-iron plow, which breaks through tough prairie soil.</p> <p>Union Pacific and Central Pacific railroads meet in Utah, the first transcontinental railroad.</p> <p>1869</p>	<p>Wyoming Territory passes first law in U.S. giving women right to vote.</p> <p>Population of Fort Worth reaches nearly 600.</p> <p>1870</p>
---	--	-------------	--	---



Artist Timeline

F.S. REMINGTON

U.S. & TEXAS

C.M. RUSSELL

Remington's family moves to Ogdensburg, NY, where Seth Pierre Remington is employed as Collector of the Port.

Remington is enrolled at the Vermont Episcopal Institute.

Congress creates Yellowstone Park in WY to help conserve the nation's endangered natural resources.

The president of the Texas & Pacific Railroad arrives in Fort Worth to study its potential as a rail point.

James brothers commit first train robbery.

Barbed wire is created.

Fort Worth passes laws against prostitution, gambling, and wearing of guns.

Tarrant County's last Indian raid occurs.

Grasshoppers destroy farms from Texas to Canadian border.

Fort Worth receives first telegraph message.

Second Sioux War erupts after Sioux tribe refuses to sell their land to the government.

1871

1872

1873

1874

1875



The First Americans
Sid Richardson Museum

F.S. REMINGTON

Remington's father dies. Remington leaves college and moves to Albany, NY to be near his uncle.

Remington works as a state clerk, quits his job, then works as a reporter for the *Albany Morning Express*.

Remington attends Highland Military Academy in Worcester, Massachusetts.

Remington attends School of Fine Arts, Yale.

General Custer and his men are killed by Chief Sitting Bull's Sioux warriors at Battle of Little Bighorn.

Duel between Buffalo Bill and Yellowhand.

First phone call made.

Railroad arrives in Ft. Worth. Fort Worth's streets lit by gaslight.

1876

Edison invents the phonograph.
First Fort Worth phone installed.

1877

A.A. Pope manufactures first bicycle in U.S.

Tarrant County's first artificial gas for lighting is manufactured.

1878

Wabash, Indiana becomes the first town to be lit completely by electric light.

Helen Keller is born.

Census totals Fort Worth population at 6,663.

1880

U.S. & TEXAS

The Artists

C.M. RUSSELL

Russell skips school to hang out around the waterfront.
Russell is sent to military school at Burlington College in Burlington, New Jersey.

Russell travels west to Montana with Wallis "Pike" Miller and works briefly on a sheep ranch. He travels with a paint box and a ball of wax in flannel cloth.

Russell meets Jake Hoover, a professional hunter.



Artist Timeline

F.S. REMINGTON

Remington travels to Montana Territory.

Submits Western sketch to *HW*. It is then published in *Harper's Weekly* Feb. 25, 1882, but the work is redrawn by W.A. Rogers.

Remington comes into family inheritance.

Remington buys sheep ranch in Peabody, Kansas. Later in the year, he travels to New Mexico territory, Dodge City, and Fort Reno, Kansas.

Remington sells sheep ranch. Invests in hardware store and saloon in Kansas City, Missouri. Marries Eva Caten in Gloversville, NY and returns to Kansas City. Eva returns to NY when silent partnership in saloon is revealed.

Loses share in saloon. Moves to Brooklyn, NY. Rejoins Eva and decides on career as artist.

U.S. & TEXAS

Shoot-out at the O.K. Corral in Tombstone, AZ.

Clara Barton organizes the American Red Cross.

First Tarrant County long distance phone call is made, to Dallas.

1881

American Baseball Association is founded.

Edison designs first hydroelectric plant in Wisconsin.

Tarrant County approves .5% tax and the first public schools open.

1882

The first Wild West Show by Buffalo Bill Cody is presented in North Platte, Nebraska.

Fort Worth's first fire station opens on Main St. between 11th and 12th. A 3,000 pound alarm bell is placed in its tower.

1883

Supreme Court declares it a federal offense to interfere with a person's right to vote. Case was brought by Southern blacks prevented from voting by the Ku Klux Klan.

Tarrant County residents receive first home delivery of mail.

1884

Congress passes act forbidding fencing of public lands in the West.

Tarrant County's first electric lights glow.

1885

C.M. RUSSELL

Russell lives with Jake Hoover, hunting and trapping, supplying local ranches and mines.

Russell works in several capacities, including night wrangler, on Montana cattle ranches.



The First Americans
Sid Richardson Museum

Remington illustrates for *HW, Harper's Young People, Outing, and St. Nicholas Magazine*. Attends Student Arts League in NYC. Moves to new apartment and sets up studio. Paints *The Ambushed Picket* and *The Riderless Horse*.



Remington moves from pen and ink drawings to wash drawings. Illustrates primarily in black and white. Visits Crow Indian Reservation. Visits Blackfeet Indian Reservation in Canada. Commissioned to illustrate Theodore Roosevelt's *Ranch Life and the Hunting Trail*.



Remington is scout for two weeks with Powhatan Clarke and Buffalo Soldiers in AZ. Goes to TX, OK.



Remington moves to New Rochelle, NY. Travels to Montana, Wyoming, and Dakota Territory. Paints *Self Portrait on a Horse*.

Remington spends 6 weeks in Mexico to gather material for articles. Paints *The Sentinel*.

F.S. REMINGTON

The Statue of Liberty, a gift from the French, is dedicated in New York Harbor.

Geronimo's Apaches surrender to U.S.

State troops and Texas Rangers are called in to Fort Worth to help move trains during railroad strike.

1886

Blizzards kill thousands of open range cattle.

Congress passes Dawes Act, dividing reservations into 160 acre plots. Land is opened to white settlers.

A gunfight erupts outside the White Elephant Saloon.

1887

Philip Pratt demonstrates first electric automobile.

Football League founded.

George Eastman perfects Kodak box camera.

Remington visits Fort Worth. Stays at Ellis Hotel.

1888

U.S. allows white settlers to claim land in Oklahoma belonging to Indians.

Fort Worth's Spring Palace built. Walls are made of wheat, corn, rice, and cotton.

Electric street car line begins operation in Fort Worth.

1889

Troops kill 200 Sioux at Wounded Knee.

Census states American frontier officially closed.

Nt'l Women's Suffrage Association formed.

Spring Palace burns.

Fort Worth's population reaches 23,076.

1890

Russell sends his first important oil, *Breaking Camp*, to St. Louis Exposition and Music Hall Association art show.

Russell paints *Waiting for a Chinook*. Biographical sketch about Russell is published in the *Helena Weekly Herald*. Spends winter of 1887-1888 among Blackfeet Indians.

Harper's publishes the first illustration by Russell, who becomes known as the "Cowboy Artist." Russell spends summer in Alberta, Canada, with Blood Indians, a branch of Blackfeet. Given Indian name "Ah-Wah-Cous."

Russell paints *Cowpunching Sometimes Spells Trouble*.



Russell paints *Cowboy Sport - Roping a Wolf* and *The Buffalo Runners*. The first anthology of Russell paintings, *Studies of Western Life*, is published.

C.M. RUSSELL

The Artists

U.S. & TEXAS



Artist Timeline

F.S. REMINGTON

Remington travels to Mexico with Eva and General Miles, to sketch the Mexican army. Exhibits watercolors at the St. Louis Museum of Fine Arts.

Remington exhibits paintings at St. Louis Exposition. Travels to Germany, Prussia, Russia, France and England gathering material for *Harper's*.

Remington exhibits works at Chicago World's Colombian Exposition. Illustrates for numerous publications. Travels to Mexico, New Mexico territory, Dakota territory, California, West Virginia and Wyoming.

Remington sketches Pullman strike and riots in Chicago. Travels to Algiers to sketch soldiers for *HW*.

Remington's first bronze sculpture, *The Broncho Buster*, is cast.

U.S. & TEXAS

Immigration increases. 560,319 arrive from abroad.

Gold is discovered near Denver, CO, in the Cripple Creek field of the Rocky Mountains.

Sid W. Richardson is born in Athens, TX.

1891

President Harrison opens 3 million acres of Cheyenne and Arapaho land in Oklahoma to white settlers.

The Sierra Club is formed to fight the destruction of forests.

1892

Professor Fredrick J. Turner reads his famous essay, "The Significance of the Frontier in American History," before a Wisconsin audience. Turner suggests the presence of a frontier has been a major force in the development of democracy in America.

1893

Flagstaff Observatory is completed in Arizona.

1894

Babe Ruth and Jack Dempsey are born.

H.G. Wells pens *The Time Machine*.

The Fort Worth Courthouse is completed at a cost of \$408,380.

1895

C.M. RUSSELL

Russell paints *Seeking New Hunting Grounds*.



Russell's works are shown at Chicago World's Colombian Exposition. Russell paints *Plunder on the Horizon* and *Trouble on the Horizon*. Secures commissions and leaves the range to pursue full-time art career.



Russell paints *Indians Hunting Buffalo* and *The Marriage Ceremony*.



Russell paints *Bringing Up the Trail* and *The Defiant Culprit*.



The First Americans
Sid Richardson Museum

F.S. REMINGTON



Remington paints *Captured*.

Remington chooses new bronze foundry, Roman Bronze Works, owned by Riccardo Bertelli.

Remington goes to Puerto Rico and Cuba to cover Spanish-American War. Work selected for commemorative stamp.

Remington travels to Montana and Wyoming, hunting elk and gathering ideas for short stories. Is a guest at Buffalo Bill Cody's ranch.

Remington travels to Texas for *Harper's*. Travels to Florida to sketch scenes of Spanish-American War.

The Supreme Court rules that "separate but equal facilities" for blacks and whites are constitutional.

1896

Nancy Cooper and Russell are married.

Oil is discovered in Bartsville, Oklahoma. Oil becomes the area's biggest industry as more strikes are made over the next several decades.

1897

Russell's stories and illustrations are published outside of Montana in *Recreation Magazine*. Paints *Captain William Clark...* and *Three Generations*.



U.S. annexes Hawaii.

Treaty of Paris is signed, ending Spanish-American War.

Jim Lowe (Butch Cassidy) and Harry Longbaugh (The Sundance Kid) set up "headquarters" in Fort Worth.

1898

Russell's father comes to Montana to visit Charles and his new wife. Nancy begins taking control of her husband's business affairs.

Butch Cassidy's gang robs first train.

Main Street in Fort Worth is paved with bricks.

1899

Russell paints *The Buffalo Hunt*.



R.A. Fessenden transmits human speech via radio waves.

Fort Worth photographer, C.L. Swartz shoots portrait of Butch Cassidy and "Hole in the Wall Gang."

1900

The Russells move to their permanent home at 1219 Fourth Ave. North, in Great Falls, Montana.

U.S. & TEXAS

C.M. RUSSELL

The Artists



Artist Timeline

F.S. REMINGTON



Remington paints *Rounded Up*, *A Sioux Chief* and *The Cow Puncher*. *John Ermine of the Yellowstone* is published.

Collier's prints portfolio of Remington's black and white illustrations.

Remington signs four year contract with *Collier's Weekly* to do 12 paintings a year of his choice in topic.

Remington paints first version of *The Unknown Explorers*.

U.S. & TEXAS

Fight between cattle ranchers and sheepherders begins years of violence.

U.S. citizenship given to Cherokees, Creeks, Choctaws, Chickasaws, and Seminoles.

Spindletop erupts in Beaumont.

1901

U.S. coal strike takes place.

Swift and Armour open plants. Fort Worth is packing house center.

1902

Orville and Wilbur Wright make the first successful airplane flight.

Tarrant County's first car is sighted on city streets.

The Great Train Robbery, Tarrant County's first movie, is shown.

1903

First U.S. Olympics takes place in St. Louis.

1904

1905

C.M. RUSSELL

Russell exhibits works in St. Louis. Receives favorable reviews as the "St. Louis Lion." Is compared favorably to Remington. Paints *Returning to Camp* and *Buffalo Hunt*.



Russell paints *Counting Coup* and *Trouble Hunters*.



Russell's first one-man show opens in St. Louis. Russell adds logcabin studio to his Great Falls home.

Russell paints *The Bucker*. Casts first bronze statuettes.



The First Americans
Sid Richardson Museum

F.S. REMINGTON

Remington paints *A Taint on the Wind*. One man exhibit held at Knoedler Gallery in NY. Nocturnes well received.



Remington burns 75 paintings. Paints *The Dry Camp*.



Remington paints *Apache Medicine Song*, *The Unknown Explorers*, and *A Figure of the Night (The Sentinel)*.



Remington paints *The Love Call*, *Among the Led Horses*, *The Buffalo Runners...* and *The Luckless Hunter*. Burns drawings. Moves to CT. Dies of peritonitis after operation for ruptured appendix.

U.S. troops occupy Cuba.

Upton Sinclair writes *The Jungle*, revealing conditions in Chicago's stockyards.

1906

Boy Scouts founded.

Immigration to U.S. restricted.

Mother's Day designated.

Fort Worth's first skyscraper, the Flat Iron Building, located at 1000 Houston St. is built.

1907

Henry Ford introduces the Model T, the first mass-produced car in the world for \$850.

Cowtown Coliseum, hailed as the largest show arena in its day, is built.

1908

Geronimo, Chiricahua Apache chief dies.

Robert Perry reaches the North Pole.

W.E.B. DuBois founds the NAACP.

The Great Southside Fire destroys 300 buildings in Fort Worth.

1909

1910

U.S. & TEXAS

Russell begins to offer summer cabin at Lake McDonald, Bull Head Lodge, as haven for artists and writers.



Paints *Utica* and *The Scout*. First one-man show in NY. Sees Buffalo Bill. Appendix removed.



Paints *First Wagon Tracks* and *When Blackfeet and Sioux Meet*. Travels with buffalo drive to Canadian roundup.



Russell paints *Wounded*. Participates in buffalo roundup as guest of Canadian government. A photo of Russell painting is shown in *Toronto Globe Saturday* magazine.



C.M. RUSSELL

The Artists



Artist Timeline

F.S. REMINGTON

U.S. & TEXAS

C.M. RUSSELL

<p>Prizes appear in boxes of Cracker Jacks.</p> <p>TCU moves from Waco to Fort Worth.</p> <p>First transcontinental flight arrives in Fort Worth.</p> <p>Sid Richardson attends Baylor and Simmons College.</p> <p>1911</p>	<p>Oreo cookie is born.</p> <p>Pres. Taft sets aside 38,000 California acres for petroleum reserve.</p> <p>Love Field established in Dallas.</p> <p>Southwest Conference for athletics is organized.</p> <p>1912</p>	<p>Armory Show introduces U.S. to post-Impressionist art.</p> <p>Income tax law goes into effect.</p> <p>Coca-Cola bottle designed.</p> <p>Willa Cather pens <i>O Pioneers!</i></p> <p>1913</p>	<p>Panama Canal opens.</p> <p>WWI begins.</p> <p>Umbrella girl appears on Morton Salt boxes.</p> <p>Fort Worth stockyards is busiest horse mule trading center.</p> <p>1914</p>	<p>The Ford Company makes its millionth car.</p> <p>Motorized taxis appear in Fort Worth.</p> <p>1915</p>
---	--	---	---	---

Russell opens one man show in New York, "The West That Has Passed." Wins commission for Lewis and Clark mural at Montana State House of Representatives.

Russell paints *A Bad One*. Attends July 4 celebration on Blackfoot reservation near Browning.

Russell travels down Missouri River with friends, reading from Lewis and Clark journals during trip.

Russells take pack train trip with Howard Eaton in Glacier Park.

"The West That Has Passed" opens in London with Charles and Nancy Russell in attendance. Russell's work garners international recognition.



The First Americans
Sid Richardson Museum

F.S. REMINGTON

The Artists

U.S. & TEXAS

C.M. RUSSELL

<p>Keds shoes are introduced.</p> <p>Mr. Peanut is created by 13-year-old in a contest by Planter's Nut and Chocolate Co.</p> <p>1916</p>	<p>U.S. enters WWI.</p> <p>Buffalo Bill Cody dies.</p> <p>Camp Bowie, a training camp of 100,000 men, is established in Ft. Worth.</p> <p>Ranger Oil Field discovered and sets off oil boom.</p> <p>1917</p>	<p>The Raggedy Ann doll is introduced.</p> <p>WWI ends.</p> <p>World's first indoor rodeo opens at the Northside Coliseum in Fort Worth.</p> <p>1918</p>	<p>The 18th Amendment is ratified, introducing prohibition in 1920.</p> <p>Sid and friend Clint Murchison drive from Wichita Falls to Red River to make first oil deal. (Within two years, each had made \$2 million in the oil game.)</p> <p>1919</p>	<p>U.S. women receive the right to vote.</p> <p>First airmail occurs, from New York to San Francisco.</p> <p>Census counts Fort Worth population at 106,472.</p> <p>1920</p>	
---	--	--	--	--	--

Russell paints *Man's Weapons Are Useless When Nature Goes Armed* (later gives to Eaton). The Russells adopt a son, Jack.



Paints *Buffalo Bill's Duel with Yellowhand* and *Deer in Forest*. Photographer Dorethea Lange and husband visit Russell at Lake McDonald.



Nancy chairs area Women's Division of the United War Work Campaign.

Russell begins spending part of each winter in Southern CA. Exhibits at Minneapolis Institute of Art. Press suggests Russell's work profits from type of lighting seen in paintings of Maxfield Parrish.

In New York's Babcock Galleries' catalogue, Russell states that "his pictures would drive the Impressionists into hysterics."



Artist Timeline

F.S. REMINGTON

U.S. & TEXAS

C.M. RUSSELL

<p>Unknown Solider is buried at Arlington National Cemetery.</p> <p>KDKA in Pittsburgh transmits first regular U.S. radio program.</p> <p>Oil drops to \$1 a barrel, and Richardson is wiped out.</p>	<p>Mr./Mrs. Dewitt Wallace found <i>Reader's Digest</i>.</p> <p>Fort Worth is home to 22 oil refineries.</p>	<p>"Yes, We Have No Bananas" is a popular song.</p> <p>The Stockyards is annexed by the City of Fort Worth.</p>		<p>Charleston dance is the rage.</p> <p>F. Scott Fitzgerald pens <i>The Great Gatsby</i>.</p> <p>Tarrant County's first airmail delivery arrives.</p>	<p>Kodak makes first 16mm movie film.</p> <p><i>Winnie the Pooh</i> is written.</p>	
1921	1922	1923	1924	1925	1926	

Russell sells *The Salute of the Robe Trade* for \$10,000. The Russells meet Hollywood stars Douglas Fairbanks and wife Mary Pickford.

Russell paints *When White Men Turn Red*.



Russell's health begins to fail.

Russell is given honorary Doctor of Law degree. Last one man show in Wasington D.C. at Corcoran Gallery of Art.

Russell's goiter removed. Dies of heart attack in Great Falls, Montana on Oct. 24.



The First Americans
Sid Richardson Museum

BIBLIOGRAPHY

- Brown, Dee. *The American West*. New York: Simon & Schuster, 1995.
- Carl, Debi. Administrative Assistant / Historian, Sid Richardson Museum, 1997.
- Dippie, Brian W. *Charles M. Russell, Word Painter: Letters 1887-1926*. Fort Worth: Amon Carter Museum, 1993.
- Dippie, Brian W. *Remington & Russell: The Sid Richardson Collection*. Austin: University of Texas Press, 1994.
- Grun, Bernard. *The Timetables of History*. New York: Simon & Schuster, 1982.
- Hallmark Cards, Inc. 1993.
- Hassrick, Peter H. *Charles M. Russell*. New York: Harry N. Abrams, 1989.
- Hassrick, Peter H., and Webster, Melissa J. *Frederic Remington, A Catalogue Raisonne: Volume II*. Cody: Buffalo Bill Historical Center, 1996.
- McCracken, Harold. *The Charles M. Russell Book: The Life and Work of the Cowboy Artist*. Garden City: Doubleday & Company, Inc., 1957.
- Pirtle, Caleb. *Fort Worth: The Civilized West*. Tulsa: Continental Heritage Press, Inc., 1980.
- Roark, Carol. *Tarrant County Historic Resources Survey*. Fort Worth: Historic Preservation Council, 1991.
- Sanders, Leonard. *How Fort Worth Became the Texasmost City*. Fort Worth: Amon Carter Museum, 1973.
- Schmidt, Ruby. *Fort Worth & Tarrant County: A Historical Guide*. Fort Worth: Texas Christian University Press, 1984.
- Smith, Carter. *Bridging the Continent, A Sourcebook on the American West*. Brookfield: The Millbrook Press, 1992.
- Smith, Carter. *Exploring the Frontier, A Sourcebook on the American West*. Brookfield: The Millbrook Press, 1992.
- Smith, Carter. *The Legendary Wild West, A Sourcebook on the American West*. Brookfield: The Millbrook Press, 1992.
- Smith, Carter. *The Riches of the West, A Sourcebook on the American West*. Brookfield: The Millbrook Press, 1992.
- Stewart, Rick. *Frederic Remington: Masterpieces from the Amon Carter Museum*. Fort Worth: Amon Carter Museum, 1992.
- The Henry Art Gallery. *Myth of the West*. Seattle: Henry Gallery Association, 1990.



Lesson Plans

Image List



Sid Richardson on Horseback, black and white photograph

p. 6



Sid Richardson Portrait, black and white photograph

p. 8



Sid Richardson Museum Interior, color photograph

p. 11



Frederic S. Remington

Buffalo Runners – Big Horn Basin

1909

Oil on canvas, 30 1/8 x 51 1/8”

p. 32-33



Charles M. Russell

Buffalo Hunt

1901

Oil on canvas, 24 1/8 x 36 1/8”

p. 34-35



Charles M. Russell

Wounded

1909

Oil on canvas, 19 7/8 x 30 1/8”

p. 36-37



Frederic S. Remington

The Luckless Hunter

1909

Oil on canvas, 26 1/8 x 34”

p. 38-39



Charles M. Russell

Returning to Camp

1901

Oil on canvas, 24 1/8 x 36”

p. 40-41



Charles M. Russell

The Marriage Ceremony

1894

Oil on cardboard, 18 1/2 x 24 5/8”

p. 42-43



The First Americans
Sid Richardson Museum



Charles M. Russell
1897

Three Generations
Oil on canvas, 17 1/8 x 24 1/4"

p. 44-45



Charles M. Russell
1902

Trouble Hunters
Oil on canvas, 22 x 29 1/8"

p. 46-47



Frederic S. Remington
1899

Captured
Oil on canvas, 27 x 40 1/8"

p. 48-49

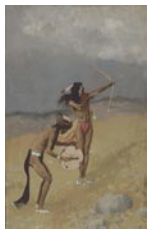

Frederic S. Remington
1892

*The Thunder-Fighters Would Take Their Bows and Arrows,
Their Guns, Their Magic Drum*
Oil on wood panel, 30 x 18"

p. 50-51



Frederic S. Remington
1908

Apache Medicine Song
Oil on canvas, 27 1/8 x 29 7/8"

p. 52-53



Frederic S. Remington
1909

The Love Call
Oil on canvas, 31 x 28"

p. 54-55



Frederic S. Remington
1908

A Figure of the Night (The Sentinel)
Oil on canvas, 30 x 21 1/8"

p. 56-57

Lesson Plans



Lesson Plans

Buffalo Runners - Big Horn Basin

Frederic S. Remington

1909

Oil on canvas, 30 1/8 X 51 1/8"

CONCEPT

Students will view, analyze and interpret the work of art. Students will learn that artists, through color and brushstrokes, can suggest movement and the illusion of space.

TEKS

The SRM Educator Guide lessons support inquiry-based discussion and align with the Texas Essential Knowledge and Skills for art, history and English language arts. To select correlations for your grade level visit the [Texas Education Agency TEKS website](#).

VOCABULARY

- **Foreground** - the part of an artwork which appears to be closest to the viewer.
- **Warm colors** - the family of related colors ranging from the reds through the oranges and yellows. Warm colors suggest warmth and seem to move toward the viewer.



DESCRIBE

Take time to look at this painting. Describe the action. Describe the countryside. What colors are predominate? What time of day is it? Where is the light coming from? Where are the shadows? What colors do you see in them? Describe what you see in the way of details. The brushstrokes in the foreground are bold and free, with thick layers of paint, color applied next to color - not blended. The brushstrokes in the middle ground are more smooth, uniform and blended.

INQUIRE

How does the artist express movement? With your hand, mimic the movement of Remington's brushstrokes (short, choppy) in the foreground of this painting. How might the way the paint is applied affect the mood of the painting? (the choppy movements mimic the action). How has he created the illusion of distance?



The First Americans
Sid Richardson Museum

SUPPOSE

Note that these men are carrying rifles. What are “buffalo runners”? At what speed are the horses moving? How do you know? Imagine what it would be like to follow hundreds of buffalo, galloping at full speed up a mountain, carrying a rifle in one hand.

INFORM

Earlier during the year that this work was painted, Remington wrote in his diary that he had “always wanted to be able to paint running horses so you would feel the details and not see them.”

It had been Remington’s desire to translate onto canvas the feelings expressed in his own words. In order to accomplish this goal, he would have to trust his own senses in portraying light and shadow, experimenting with color and applying paint more boldly.

Regarding the use of color, Remington wrote these words of advice to wildlife painter Carl Rungius:

If you will permit me to observe, I will say I think the lighting in your studio is too cold. I have found the same trouble and two years ago I painted or stained both my studio here and my summer one a rich red which had the effect of warming up my paint immediately. Why don’t you try it?

EXTEND See pg. 58

Historian Brian Dippie believes that this painting reflects the emotions of Remington’s earliest Western experiences. In his first published article, Remington describes the emotions he felt on an early morning ride across the Kansas prairie. Remington writes of a horse whose:

stride was steel springs under me as she swept along, brushing the dew from the grass of the range and taking the bit smartly in her teeth as though to say, ‘Come on, let’s have a run’....On over the smiling reach of grass, grown dry and sere in the August suns and hot winds, we galloped four abreast....The horses tore along, blowing great lung-fulls of fresh morning air out in snorts.

Was Remington “able to paint running horses so you would feel the details and not see them”? Ask students what they feel in this painting that they cannot see. i.e., Do you see sweat? No, but you feel it because... Do you see the wind? No, but you feel it because... Do you see the springing of the horses? What else do you feel but do not see?

Compare and contrast Remington’s *Buffalo Runners - Big Horn Basin* with Russell’s *The Buffalo Runners*.



Lesson Plans

Buffalo Hunt

Charles M. Russell

1901

Oil on canvas, 24 1/8 x 36 1/8"

CONCEPT

Students will view, analyze and interpret the work of art. Students will learn that artists, through depiction of characters, action, and setting, can depict a narrative painting which records aspects of the customs of a culture.

TEKS

The SRM Educator Guide lessons support inquiry-based discussion and align with the Texas Essential Knowledge and Skills for art, history and English language arts. To select correlations for your grade level visit the [Texas Education Agency TEKS website](#).

VOCABULARY

- **Focal point** - the center of interest in an artwork



DESCRIBE

What is happening in this painting? Squint your eyes. Where does your eye travel to first (the focal point)? Where do the buffalo seem to be heading? Describe the man on the left. How is he dressed? What is on his head? What is he doing? What is his weapon? Where does he store his weapons? Now describe the hunter on the right. What is his weapon? Are there any other hunters in view? How far out into space can you see in this painting? How has the artist created a sense of distance?

INQUIRE

Is there a sense of tension or relaxation in this scene? Name three clues that indicate movement, i.e., dust cloud, angle of riders, crush of buffaloes.

How does the position of the bison make you feel as if you are involved in this hunt?



The First Americans
Sid Richardson Museum

SUPPOSE

Imagine an arrowhead shape formed by the two hunters and the herd of buffalo. Where does it point?

INFORM

The type of hunting method depicted in this artwork is called the traditional surround, in which hunters encircled the buffalo herd, forcing the herd to move in a circle. The work also illustrates elements of the parallel chase, in which the bowman and the lancer approach from opposite sides of the herd.

Brian Dippie, professor of history at the University of Victoria, British Columbia, explains that the Plains Cree may have never used a lance in buffalo hunting, and the Blackfeet had virtually abandoned it by 1870. According to Dippie's source, when a Blackfoot did use a spear, he held it with two hands and, holding it overhead, thrust it downward. A hunter's arrow would be "directed...at the vital spot immediately behind the (buffalo's) forelegs." The red headband may represent the custom of the Assiniboines, who tied their hair with bands on top of their heads prior to the hunt.

Russell painted a number of works depicting buffalo hunts. This representation, according to Dippie, is distinctive in its composition. The "surging herd has been bunched so tightly by the pressure of the hunters on the flanks and at the rear that it forms a triangular mass moving directly at the viewer like an arrow in flight."

EXTEND See pg. 58

Using the Venn diagram in this packet, compare and contrast this work with its partner, *Returning to Camp*. Write about how they are similar and how they are different.



Lesson Plans

Wounded

Charles M. Russell

1909

Oil on canvas, 19 7/8 x 30 1/8"

CONCEPT

Students will view, analyze and interpret the work of art. Students will learn that artists, through placement of characters in a composition, can portray a moment of action and drama.

TEKS

The SRM Educator Guide lessons support inquiry-based discussion and align with the Texas Essential Knowledge and Skills for art, history and English language arts. To select correlations for your grade level visit the [Texas Education Agency TEKS website](#).

VOCABULARY

- **Atmospheric perspective** - a method of implying depth and distance in a painting by using fading colors and hazy details in distant objects.
- **Perspective** - method used (linear or atmospheric) to depict the illusion of depth on a two-dimensional surface.
- **Symbol** - a visual image that stands for something else, especially a letter, figure or a sign that represents a real object or idea.



DESCRIBE

Look closely at the painting. Where does the action take place? What is happening? What clues does the artist give you, i.e., horse's face, and the raised leg of the hunter? How many hunters are there? Describe the actions of the white horse and its rider. What weapon does the hunter carry? What has angered the bull? Do you see any buffalo calves? Are there other people in the painting? Where are they and what are they doing? Trace the buffalo herd's line of movement, as they travel from far across the horizon up till the point where they encounter the hunters. (Point out the perspective). Where are the brightest colors? Name them. Where are the palest colors? Name them. Why did the artist use the brightest colors in the foreground?

INQUIRE

The buffalo are great in number. At what speed do they seem to be traveling? What is the season? What clues does the artist give you about the season? (small patches of snow) Could it be the end of spring, beginning of winter? Justify your choice of season.



The First Americans
Sid Richardson Museum

SUPPOSE

Who will master this situation, the buffalo or the hunters? Find the rabbit hidden in the grass. Why would the artist include this small creature in the midst of such intense action?

INFORM

One of the most prized possessions of the Plains Indian hunter was his buffalo horse. In October of 1908, Russell had the opportunity to participate in a buffalo roundup on the Flathead Reservation in Montana. During the roundup, Russell himself escaped a close brush with an angry bull. This experience may have helped give a sense of immediacy to the action Russell portrayed in *Wounded*.

In "How Lindsay Turned Indian," a short story written by Russell, the author wrote about the many virtues of the valued buffalo horse:

In them days buffalo hosses was worth plenty of robes. This animal had to be sure-footed, long-winded, an' quick as a cat. It's no bench of a hoss that'll lay alongside of a buffalo cow, while you're droppin' arrows or lead in her. He's got to be a dodger... 'cause a wounded cow's liable to get ringy or on the fight, an' when she does, she's mighty handy with them black horns.

EXTEND See pg. 59

The buffalo was the most important food source for the Plains Indian. Fresh buffalo meat was roasted over the fire or boiled. Meat not eaten at once was cut up into strips and hung up on racks to dry. Pemmican, made by pounding up dried meat with fat, with the addition of berries often added for flavor, was a staple.

The buffalo, however, provided much more than meat. It also provided clothing, housing, tools, transportation and fuel. Make up a list of possible uses for the parts of a buffalo, and then compare your list with the list included in the packet. (Source for information on uses of buffalo: American Bison Association, PO Box 16660, Denver, CO., 80216).



Lesson Plans

The Luckless Hunter

Frederic Remington
1909

Oil on canvas, 26 7/8 x 28 7/8"

CONCEPT

Students will view, analyze and interpret the work of art. Students will learn that artists can create a narrative painting which uses color to depict time of day and to evoke mood.

TEKS

The SRM Educator Guide lessons support inquiry-based discussion and align with the Texas Essential Knowledge and Skills for art, history and English language arts. To select correlations for your grade level visit the [Texas Education Agency TEKS website](#).

VOCABULARY

- **Cool colors** - family of related colors which ranges from the greens through the blues and violets. Cool colors suggest coolness and seem to recede from the viewer.
- **Symmetry** - a form of balance in which parts on both sides of a center line are similar.



DESCRIBE

In this work of art, Remington presents a characterization of an American Indian that may be different from other works you have seen. Ask students what images come to mind when they think of depictions they have seen of Native Americans (warriors). Are there similarities among responses?

Look closely at the Native American depicted in *The Luckless Hunter*. Can you think of some words to describe him? How do you think he feels? What is he doing?

Describe the setting. What is the time of year? How does the artist express this? Time of day? Name the colors used by the artist. Are they warm or cool colors? From which direction is the wind blowing? What is in the background? Describe the landscape in the foreground. Where are the Native American and his horse situated on the picture plane? What impact does this have on the painting and to you as the viewer? Is the balance symmetrical or asymmetrical?



The First Americans
Sid Richardson Museum

INQUIRE

What has happened to *The Luckless Hunter*?

SUPPOSE

What sounds might you hear if you were able to step into this painting?

Do you think that this is a portrait of a Native American person that Remington knew personally, or could it represent a sentiment about the American Indian?

INFORM

Late in Remington's life, the artist frequently painted pictures without clear victories. This painting was completed during the last year of Remington's life. Noted historian Brian Dippie believes that after Remington passed his 40th birthday he recognized his growing physical decline, and mourned the fading of the Wild West. Remington became a "student of mood, and some of his paintings were infused with a brooding intensity."

EXTEND See pg. 58, 64

Write a story that expresses the mood of this painting.

Compare and contrast this painting with other depictions of Native Americans, such as Remington's *Captured* or Charles Russell's *Trouble Hunters*.

Write an imaginary conversation which could take place between the Native American in Frederic Remington's *The Luckless Hunter* and the Native American depicted in Charles Russell's *The Scout*.



C. Russell, *The Scout* 1907



Lesson Plans

Returning to Camp

Charles M. Russell

1901

Oil on canvas, 24 1/8 x 36"

CONCEPT

Students will view, analyze and interpret the work of art. Students will learn that artists, through the illustration of characters, action, and setting, can depict a story that records aspects of a culture.

TEKS

The SRM Educator Guide lessons support inquiry-based discussion and align with the Texas Essential Knowledge and Skills for art, history and English language arts. To select correlations for your grade level visit the [Texas Education Agency TEKS website](#).

VOCABULARY

- **Background** - the parts of an artwork which appear to be farthest away from the viewer and lie behind objects in the foreground and middle ground.
- **Travois** - a frame slung between trailing poles and pulled by a dog or a horse, formerly used by Plains Indians to carry their belongings.



DESCRIBE

Look carefully at the people and animals represented. Describe the person on the horse that appears closest to us. How is she dressed? What is she carrying? What gesture is she making? What is the horse carrying? How is that object being transported? What is the young boy carrying? What animals/figures follow the woman and the buffalo carcass? What is the old woman doing? Is this group traveling together or separate? Can you describe their destination? How has the artist implied distance? Describe the difference between the colors/details of the foreground and the colors/details of the background.

INQUIRE

What is the story of this painting? What might be the relationship between the young boy and the woman on the horse? The depiction of the young boy holding a rabbit skin may foretell the young boy's future role. How do you think the women's role in this tribe might differ from the men's role?



The First Americans
Sid Richardson Museum

SUPPOSE

Why do you think Russell portrayed all the many details of costume and adornment? (It is thought that Russell may have spent a short time with the Blood Indian tribe and would have been aware of the details of costume and adornment).

INFORM

This painting is part of a matched set, a “sequel,” to Russell’s *Buffalo Hunt*. *Buffalo Hunt* portrays the events prior to this scene, in which the women and children are returning to camp with the spoils of the buffalo hunt.

The matched set belonged for many years to Maurice S. Weiss, a saloonkeeper who displayed the paintings at several locations. In Helena, Montana, they were displayed at the Old Stand Saloon, the Weiss Cafe, and the Placer Hotel; in Butte, Montana, they hung at the Finlon Hotel.

EXTEND See pg. 58

Using a Venn diagram, compare and contrast this work with its partner, *Buffalo Hunt*. Write about your findings.

Research the responsibilities and roles of each member of a Plains Indian family. How did those individual roles contribute to the entire community’s welfare? Do you have responsibilities and roles in your family? Your community? How are they similar to that of this young boy? How are they different?

Pretend you are the woman riding the horse in *Returning to Camp*, or one of the men in *Buffalo Hunt*, and that you are about to retire. Write a job description for your replacement.

Compare this work with another Russell painting, *Seeking New Hunting Grounds*, painted in 1891.



C. Russell, *Seeking New Hunting Grounds* 1891



Lesson Plans

The Marriage Ceremony

Charles M. Russell

1894

Oil on cardboard, 18 1/2 x 24 5/8"

CONCEPT

Students will view, analyze and interpret the work of art. Students will learn that artists, through detailed depiction of characters, action, and setting, can record aspects of the traditions of a culture.

TEKS

The SRM Educator Guide lessons support inquiry-based discussion and align with the Texas Essential Knowledge and Skills for art, history and English language arts. To select correlations for your grade level visit the [Texas Education Agency TEKS website](#).

VOCABULARY

- **Culture** - the behaviors, customs, ideas and skills of a group of people.



DESCRIBE

Do not reveal the title of the painting. Take a moment to study this painting. What is happening? Describe the actions of the woman on the left. What has caused her to drop the item at her feet? Describe the expression on the woman's face. Describe the actions and clothing of the man on the right. Where has the artist placed the young man in the setting? How old are these people (children? teens? adults?) What colors are repeated in this painting, and where are they located? Where is this scene set? What is in the background? Are there any other figures in view? What are they doing? Are they aware of the meeting taking place between the man and woman?

INQUIRE

Ask students to describe marriage ceremonies they have attended. Reveal the painting's title. Does this scene resemble any of the marriage ceremonies anyone has ever seen?



The First Americans
Sid Richardson Museum

Look at the young woman's facial expression. How has the artist suggested that the man has caught her by surprise? Now listen to Russell's explanation of Native American courtship as represented in one of Russell's short stories:

He's bout nineteen -- the age the Reds begin looking for a mate -- when he starts ridin' 'round on a painted pony an' puttin' in his time lookin' pretty. When a bunch of young squaws is down gettin' water, he accidentally rides through the creek, givin' them a chance to admire him. He's ablaze with paint an' feathers -- to hear him tell it he's rigged out so it hurts your eyes to look at him.

SUPPOSE

Single Plains Indian women were strictly chaperoned during the day as they performed necessary duties such as picking berries, digging for roots, and gathering wood. This young woman's chaperone left her unattended. Do you think this young man and woman know each other? How do you think the woman will respond? Do you think they will marry?

INFORM

Brian W. Dippie, historian, explains that it was a common practice for a single man to take his horse to water and then linger by the water to admire and be admired by a young woman who caught his eye. A humble suitor might flatter the young woman of his intentions by saying things like: "Did you say something? Perhaps I am mistaken. You have been in my thoughts so much and I have imagined many times that you have spoken to me.....If you haven't said anything, it is well and good, for I am like dirt under your feet and why should you waste your kind voice on lowly things...." A bolder suitor might take the direct approach, as exhibited in *The Marriage Ceremony*. In some tribes, such as the Plains Cree and the Blackfeet, un-chaperoned single women had no recognized privilege in refusing such advances.

Believing that the young man's attentions were welcomed by the young woman, this painting appealed to life-long bachelor Sid Richardson's sentimental side, and it hung over his bed in his home on San Jose Island.

EXTEND

Find out if customs such as the one represented in *The Marriage Ceremony* are still practiced by Native American tribes today. Invite a Native American to speak to the class about the courtship and marriage customs of her/his tribe.

How do your culture's courtship customs mirror and differ from those of the young Native American suitor described in Russell's short story?

Read *The Flute Player* by Michael Lacapa.



Lesson Plans

Three Generations

Charles M. Russell

1897

Oil on canvas, 17 1/8 x 24 1/4"

CONCEPT

Students will view, analyze and interpret the work of art. Students will learn that artists, through depiction of characters, action, and setting, can tell a story.

TEKS

The SRM Educator Guide lessons support inquiry-based discussion and align with the Texas Essential Knowledge and Skills for art, history and English language arts. To select correlations for your grade level visit the [Texas Education Agency TEKS website](#).

VOCABULARY

- **Narrative art** - art which suggests or tells a story.



DESCRIBE

Do you think these people know each other? Describe each figure in the painting. How are they dressed? How are the figures arranged in the composition? What imaginary geometric shape do they form? How does the arrangement of the figures suggest that this could be a family grouping? Describe the setting. Describe the background. Can you determine the time of day? Did the artist use bright or dull colors? Do you think that colors affect the mood of a painting? How?

INQUIRE

Describe the position of the young woman's body. How does it contrast with the older woman's posture? How does the posture of the older woman emphasize her age? What clues are given to indicate the stages of life?



The First Americans
Sid Richardson Museum

SUPPOSE

What do you think this painting is about?

Imagine a conversation between the two women. Write down three or four sentences they might say to one another. Which one of the women might see the baby as a symbol of her past? Which one of the women might see the baby as a promise of the future?

INFORM

During his lifetime, Charles Russell depicted many scenes about the domestic life of Native Americans. Beautiful young women were frequently portrayed in works he painted during the 1890s. Some scholars think that Russell contemplated a permanent relationship with a Blood Indian woman during a summer he spent in Alberta in 1888.

EXTEND

The old woman in *Three Generations* is said to represent Russell's vision of the last stage of Indian womanhood. A figure similar to her can be seen in several other paintings by Russell.

Guess the age of the old woman in *Three Generations*. You may be surprised to learn that it is possible that the woman depicted in Russell's painting might have been in her 40s. Twentieth century women in their 40s would not appear as aged and stooped as this woman of the 19th century. What does this painting tell you about the lifestyle and culture of the women represented? (differences in diet, health care, education, jobs) What conveniences do 21st century mothers have which 19th-century women did not? During the time in which this work was painted, what hardships did women encounter in their daily chores that made them old beyond their years?

What tales could the old woman tell you? Pretend you have had a conversation with her about her life experiences. Write a poem that expresses her feelings.

Read a short story about Native American daily life. Portray one of the events described in the story in a painting.

Interview a family member. What dreams does s/he have for you and your future? What memories does s/he have about her/his own childhood? How are these dreams and memories alike/different from the ones that these women might have for the baby in Russell's painting?



Lesson Plans

Trouble Hunters

Charles M. Russell

1902

Oil on canvas, 22 x 29 1/8"

CONCEPT

Students will view, analyze and interpret the work of art. Students will learn that artists, through the depiction of characters, action, and setting, can tell a story.

TEKS

The SRM Educator Guide lessons support inquiry-based discussion and align with the Texas Essential Knowledge and Skills for art, history and English language arts. To select correlations for your grade level visit the [Texas Education Agency TEKS website](#).

VOCABULARY

- **Contrast** - the degree of difference between colors, shapes, and other elements in an artwork (i.e., light and dark, rough and smooth).



DESCRIBE

Where does this scene take place? Look carefully at the three main figures. Where are they facing? Describe the person on the far left. What is he wearing? What is he doing? What might he be searching for? What is the middle figure doing? How is the man on the right dressed? What weapons does each man carry? Do you think that there are more men of their party approaching? What is the time of day? Where is the light coming from? Where are the most intense colors? How are they different from the colors in the background? What effect does that produce?

INQUIRE

Where are the shadows? Do shadows ever have a symbolic meaning (good or evil)? Do you think they might be symbolic in this painting? The sunlight is washing over the three central figures. How would you characterize the three men? What is the mission of the "trouble hunters"? Are they ready for battle, or reluctant to get in a fight? Why?



The First Americans
Sid Richardson Museum

SUPPOSE

What if the men could speak to you? What would they tell you about themselves and this scene? Who, or what, is the object of the hunters' gaze? What do they intend to do?

INFORM

Historian Brian Dippie explains that Plains Indian warfare was usually unsystematic and unrelated to larger tribal goals:

Young men followed an experienced warrior in hopes of stealing horses, and, should the need arise, winning war honors, or coups, in combat with the enemy. Raiding parties tended to be small...and since the object was horses, not battle, the ideal raid was one in which the horses were taken without even arousing the owners.

However, the group in *Trouble Hunters* seems to be intent on a different mission:

The men bristle with weapons...suggesting that they are out for blood and would welcome a fight. Such scalp parties were usually fairly large in size. Two or three scouts moved ahead of the main body, as Russell has shown. Apparently they have spotted something and are waiting for the others to catch up.

The original owner of this painting, Alice Chadwick Biggs, was inadvertently responsible for the meeting of Charles Russell and his future wife, Nancy Cooper. Biggs helped Nancy, who was fourteen when her mother died in Helena in 1894, secure a position in the home of the Robert's family in the town of Cascade, Montana. It was there that Nancy met Charlie; they wed in 1896.

EXTEND See pg. 58

How does this depiction of Native American hunters compare with Frederic Remington's depiction of a Native American hunter in *The Luckless Hunter*? Write about how they are similar and how they are different.

Do you think that there are "trouble hunters" in every culture and every generation? Can you name some?



Lesson Plans

Captured

Frederic Remington
1899

Oil on canvas, 27 x 40 1/8"

CONCEPT

Students will view, analyze and interpret the work of art. Students will learn that artists can create a narrative painting that tells a story from a particular point of view.

TEKS

The SRM Educator Guide lessons support inquiry-based discussion and align with the Texas Essential Knowledge and Skills for art, history and English language arts. To select correlations for your grade level visit the [Texas Education Agency TEKS website](#).

VOCABULARY

- **Parfleche** - a container made of rectangular pieces of rawhide used by Plains Indians.
- **Viewpoint** - the position or place from which an artist views his or her subject to be represented.



DESCRIBE

Take a moment to study the painting. Look carefully. Observe the people. Notice how they are grouped. How many people are gathered around the fire? Is this a meeting of friends or enemies? How is the captive dressed? What clues has the artist given you about emotions the captive might be feeling? (Fists clenched, chin jutting forward)

Where is this scene taking place? What time of year is it? What colors used to depict the ground helped you determine the season? What other clues help you to determine the weather? (Fire, Native American men wrapped in blankets) Even if the captive were able to escape, consider how hard it would be for him to survive without shoes and adequate clothing in this environment.

INQUIRE

Of the Indians grouped around the fire, is there one who appears to be more important? Why does he seem important? (Standing, two feathers, the way he holds his head) What role might he play?



The First Americans
Sid Richardson Museum

Did you notice the tiny figure in the background that is perched on the edge of the mountain? Look for clues that may tell you about him. (Feather, weapon) Who or what is the man on the edge of the mountain looking for? Why would the artist include the figure on the edge of the mountain? How does it affect your interpretation of the story?

From whose point of view does Remington present this scene? Are you sympathetic to the soldier or to the Native Americans? Why?

SUPPOSE

Does Remington give us any clues to help us determine why the Indians have captured this man? What event may have taken place?

Imagine you could hear the men's conversation. What would they be saying to one another? What do you predict will happen next?

INFORM

What does the work reveal about the time and place in which it was made? According to Brian Dippie, professor of history at the University of Victoria, British Columbia, this artwork expresses a "perception of the Western Indians that justified their defeat and displacement." This was a popular theme depicted by many artists of the day.

Remington painted *Captured* in 1899. Look up the years 1887, 1889, 1890 and 1892 in this packet's chronology to find out information about battles with, or the relocation of, Native Americans.

EXTEND See pg. 58, 61-3

Imagine that you are one of the figures depicted in *Captured*. Write a letter home describing what is happening in this scene, from your character's point of view. Read your letter aloud, asking classmates to guess which character you are, based upon the descriptive details you have included in your letter.

Locate the parfleche depicted in the artwork. (Look for the striped, rectangular shaped object in the right foreground of the painting). What is the purpose of a parfleche? Find out how it is made, and of what materials. Make a paper parfleche to carry your paper, following the directions included in this packet.

View other artworks from the 19th-century which depict the subject of captivity. Select one of these images. From whose point of view is the story portrayed? Explain why. Using the "Compare and Contrast" form, write about how it is similar and how it is different from *Captured*.

To further explore the theme of captivity, you may also wish to view Charlie Russell's *The Defiant Culprit*, also in the Sid Richardson Museum. This painting depicts the capture of a Sioux Indian by a Blackfoot tribe.



Parfleche, Sioux Tribe. Cowhide. 22 x 14 inches. Plains US Region, c. 1880-90. The Southwest Museum. Photo by Don Farber.



Lesson Plans

The Thunder-Fighters Would Take Their Bows and Arrows, Their Guns, Their Magic Drum

Frederic Remington
1892

Oil on wood panel, 30 x 18"

CONCEPT

Students will view, analyze and interpret the work of art. Students will learn that artists sometimes create artwork to illustrate and enhance understanding of the written word.

TEKS

The SRM Educator Guide lessons support inquiry-based discussion and align with the Texas Essential Knowledge and Skills for art, history and English language arts. To select correlations for your grade level visit the [Texas Education Agency TEKS website](#).

VOCABULARY

- **Illustrator** - an artist who creates designs and artworks for books or periodicals that explain the text or show the events in a story.



DESCRIBE

What is happening? What is the man on the left doing? What is the figure on the right doing? Describe the setting. What colors do you see in the clouds? How would you describe the weather? Can you find evidence of wind?



The First Americans
Sid Richardson Museum

INQUIRE

Read the work's title. Why do you think the men are called "Thunder-Fighters?" How are they "fighting" the thunder? What do you think the figure with the bow and arrow is aiming at? (The Sioux imagined the thunder source to be a black thunderbird with beating wings that filled the air with roaring.)

SUPPOSE

There was once a third figure in this painting, but Remington chose to paint over him. Can you guess where the third figure might have been? (The figure, now covered with paint, stood further up on the hill behind the man who is beating the drum.) The title tells you what the missing figure was holding. Why do you think that Remington chose to paint over the figure?

INFORM



Hassrick, Peter H. and Melissa J. Webster. *Frederic Remington: A Catalogue Raisonné of Paintings, Watercolors and Drawings, Volume I*. Cody: Buffalo Bill Historical Center, 1996.

The painting with three figures was published in the 1892 edition of Francis Parkman's book *The Oregon Trail*. He describes the actions of the Sioux:

Whenever a storm which they wished to avert was threatening, the thunder-fighters would take their bows and arrows, their guns, their magic drum, and a sort of whistle made out of the wing-bone of the war-eagle, and thus equipped, run out and fire at the rising cloud, whooping, yelling, whistling, and beating their drum, to frighten it down again.

Remington occasionally repainted finished works. In addition to painting over the third figure, he added the design that decorates the drum. The drum's design is based upon a similar one in his collection.



Remington Studio Collection, Buffalo Bill Historical Center, Cody, WY

EXTEND See pg. 65

Write a new title, perhaps one that might change a viewer's interpretation.



Lesson Plans

Apache Medicine Song

Frederic Remington

1908

Oil on canvas, 27 1/8 x 29 7/8"

CONCEPT

Students will view, analyze and interpret the work of art. Students will learn that artists use color and contrast to depict time of day and evoke mood.

TEKS

The SRM Educator Guide lessons support inquiry-based discussion and align with the Texas Essential Knowledge and Skills for art, history and English language arts. To select correlations for your grade level visit the [Texas Education Agency TEKS website](#).

VOCABULARY

- **Impressionism** - an art movement that began in France in the 1860s. Impressionists implied space and form through varying intensities of light and color.



DESCRIBE

Take a moment to study this painting. Look carefully. How many figures do you see? How are the figures grouped? In what positions are they seated? How are they dressed? Do you think that one figure might be more important than the others? Why or why not? What is placed upon their foreheads? Are you able to see all of their faces? Describe their faces, and their facial expressions. Are their mouths open? What might they be doing? (singing, chanting, praying) Where does this scene take place? What time of day is it? Where is the light coming from? (Fire, moon) How do you know? Is there another source of light? (Fire) What is in the background? (lodge) It is difficult to see the lodge clearly. What is in the foreground? What other objects do you see (i.e., smoke, and pots)? What is the season? How do you know? How does Remington create the illusion of firelight and shadow? (color, contrast) Are the edges of the shapes hard or soft? How do the soft edges affect the mood of the work?



The First Americans
Sid Richardson Museum

INQUIRE

What is happening in this scene? What are the men doing? What would you guess is their relationship to each other? How does the artwork make you feel? What is it about the work that makes you feel this way? How would the mood change if depicted at another time of day?

SUPPOSE

If you were sitting around the fire with these men, what sounds might you hear? Smells? What thoughts and feelings would you have?

For what occasions would groups of people in our society gather together in song? The chanting warriors in *Apache Medicine Song* may be participating in a sacred rite. How would your response to the artwork change if its title were changed (i.e., *Apache War Song*)?

INFORM

According to historian Brian Dippie, Remington had always been attracted to campfire scenes. In an assignment for the July 1889 issue of *Century Magazine*, Remington writes of a campfire scene that he witnessed:

It grew dark...Presently, as though to complete the strangeness of the situation, the measured 'thump, thump' of the tom-tom came from the vicinity of a fire some short distance away. One wild voice raised itself in strange discordant sounds, dropped low, and then rose again, swelling into shrill yelps, in which others joined... We drew nearer, and by the little flickering light of fire discerned half-naked forms huddled with uplifted faces in a small circle around the tom-tom. The fire cut queer lights on their rugged outlines, the waves of sound rose and fell, and the 'thump, thump, thump' of

the tom-tom kept a binding time. We grew in sympathy with the strange concert, and sat down some distance off and listened for hours....The performers were engaged in making medicine for their growing crops, and the concert was a religious rite, which, however crude to us, was entered into with a faith that was attested by the vigor of the performance.

What does the word "crude" mean? Do you think that *Apache Medicine Song* depicts a crude ceremony? How do Remington's words reflect the way some people thought about Native Americans and their traditions in the 19th century?

At the time this work was painted, Remington had viewed and studied the work of French Impressionist artist Claude Monet, as well as the works of American Impressionists. Impressionists sought to paint a sensation, rather than create works that imitated nature. In your opinion, does this painting imitate nature (look like a photograph), or capture a sensation/mood?

EXTEND

 See pg. 58, 60

View works by Claude Monet. What similarities can you find between the work of Monet and Remington? Find examples of artwork by American Impressionists who captured the sensation of moonlight.

Compare Remington's use of color in *Apache Medicine Song* and *The Love Call*. How are they similar? Different?

Compare Remington's portrayal of Native Americans in *Apache Medicine Song* and *Captured*. How are they similar? Different? Which do you prefer? Why?

Write a class fan poem that expresses the meaning of this painting. Instructions are included in this packet.



Lesson Plans

The Love Call

Frederic Remington

1909

Oil on canvas, 31 x 28"

CONCEPT

Students will view, analyze and interpret the work of art. Students will learn that artists use color to evoke mood.

TEKS

The SRM Educator Guide lessons support inquiry-based discussion and align with the Texas Essential Knowledge and Skills for art, history and English language arts. To select correlations for your grade level visit the [Texas Education Agency TEKS website](#).

VOCABULARY

- **Nocturne** - a painting of a night scene.

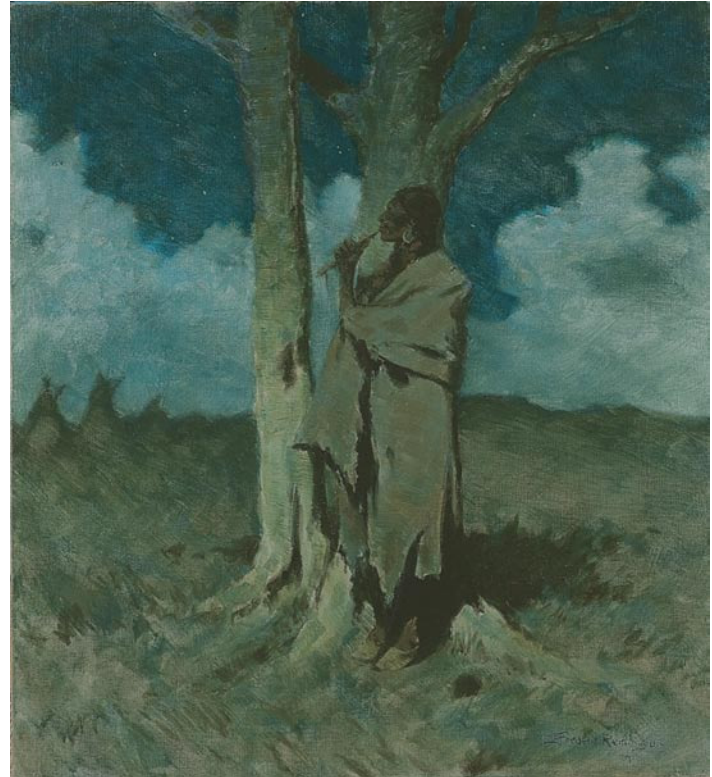

DESCRIBE

Study the painting. Write down the first word that comes to mind to complete the following sentence: "One word that describes the mood of this painting is -----." Share your response with your classmates, noting similarities and differences. What qualities in the painting (color, contrast, subject matter) influenced each person's response?

Where does this scene take place? Describe the figure. How is he dressed? What is in his hand? What is he doing? Where is he facing? What objects are in the background? Are other people in view? What time of day has Remington chosen to depict? What colors in the painting tell us that it is evening? How do the colors contribute to the mood? Where is the light coming from? Where are the shadows?



The First Americans
Sid Richardson Museum

INQUIRE

The title of this painting is *The Love Call*. For whom does the Native American play his flute? Notice that he stands so that the trees will prevent anyone who might be in the tipis from seeing him.

SUPPOSE

Why would the artist choose this time of day for the setting? How would the mood change if the event portrayed was depicted in daylight?

If you could be in this scene, what sounds would you hear?

INFORM

This oil painting was painted in one day in the last year of Remington's life. (Note the loose brushstrokes in the foreground of the painting). In his diary, Remington noted that he also worked on two other paintings that same day.

Little is known about *The Love Call*, but it has an interesting history. In October of 1965 Pope Paul VI came to the United States and visited President Lyndon Baines Johnson. The painting was loaned to be used as a backdrop for a meeting between the Pope and the President at the Waldorf Astoria in New York City. The painting remained in private collections and was exhibited only twice before it was acquired by the Sid Richardson Museum in 1996.

EXTEND See pg. 61

Paint a painting that tells a story that takes place at night, using some of the colors Remington used in *The Love Call*. Use a variety of brushstrokes.

Pretend you are the person for whom the love call is being played. Write a letter to the flute player in response to the call.

Listen to Native American flute music. Read [The Flute Player](#) by Michael Lacapa.



Lesson Plans

A Figure of the Night (The Sentinel)

Frederic Remington

1908

Oil on canvas, 30 x 21 1/8"

CONCEPT

Students will view, analyze and interpret the work of art. Students will learn that artists use color and contrast to depict time of day and to evoke a mood.

TEKS

The SRM Educator Guide lessons support inquiry-based discussion and align with the Texas Essential Knowledge and Skills for art, history and English language arts. To select correlations for your grade level visit the [Texas Education Agency TEKS website](#).

VOCABULARY

- **Composition** - the arrangement of elements of an artwork to make it an effective expression of the artist's ideas.

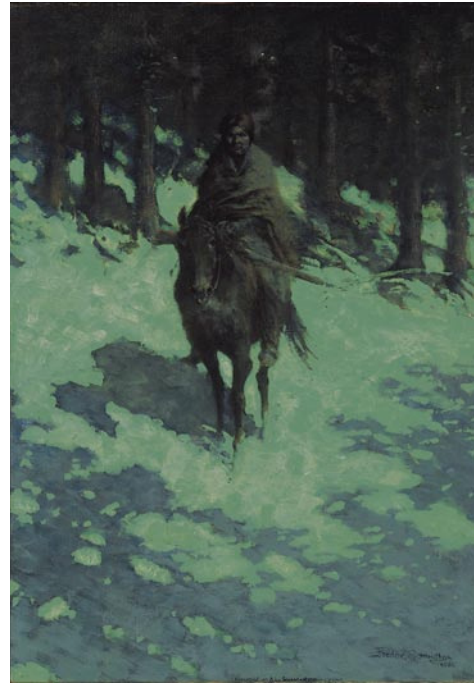

DESCRIBE

Describe this scene. How is the figure dressed? What is he carrying? Where is he looking? Describe the trees in the background. Point out the light and dark areas of the painting. How many different colors do you see? Do the colors help us to determine the time of day? What might be providing the light which has caused the shadows in the foreground? What do the small dots of light among the trees represent? What visual clues indicate the time of year?

What is the mood of this painting? How do the colors help create this mood? The colors of the figure are much the same as the colors of the background. Would your response to the painting change if the figure was set in a forest of bright daylight? What is more important in this painting -- details or mood?



The First Americans
Sid Richardson Museum

INQUIRE

Why is this man alone in the forest? Why does he carry a gun? What does the word “sentinel” mean? Where are the Native American and his horse situated on the picture plane? What impact does placing him in the center of the composition have upon our interpretation?

SUPPOSE

Does it seem as if Remington’s figure is looking directly into our eyes?

What is the unseen danger in this painting? Why would Remington leave it up to the viewer to picture the unseen danger? If you were able to step into this painting, what sounds might you hear? What sounds would imply danger? What sounds would be comforting?

INFORM

In *A Figure of the Night*, the story lies not within the picture plane, but rather within the viewer’s imagination. Compare these two Remington quotes, the first from the year 1891 and the second from the year 1902, which reflect the evolution of his style:

Observe the things in nature which captivate your fancy and above all draw--draw--draw--and always from nature. Do not try to make pictures.

When you are studying--do the thing simply and as you see it....

Big art is a process of elimination. Cut down and out--do your hardest work outside the picture, and let your audience take away something to think about--to imagine...What you want to do is to just create the thought--materialize the spirit of a thing...then your audience discovers the thing you held back, and that’s skill.

EXTEND See pg. 58, 61

Compare *A Figure of the Night* with one of Remington’s earlier, illustrative works, such as *The Sentinel*. How did his style change? Which style do you prefer? Why? Pretend you are a critic who lived during Remington’s lifetime and present a persuasive speech defending your choice of style.

Write a poem that describes the mood of *A Figure of the Night*.



Student Activities

COMPARE & CONTRAST

Choose two works of art to compare and contrast. Study them carefully. In the open area of the left circle, list the characteristics that are true only to artwork #1. In the open area of the right circle, list the characteristics that are true only to artwork #2. In the area where the two circles overlap, list the characteristics that are true of both artworks.

ARTWORK #1

unique characteristics

shared
characteristics

ARTWORK #2

unique characteristics

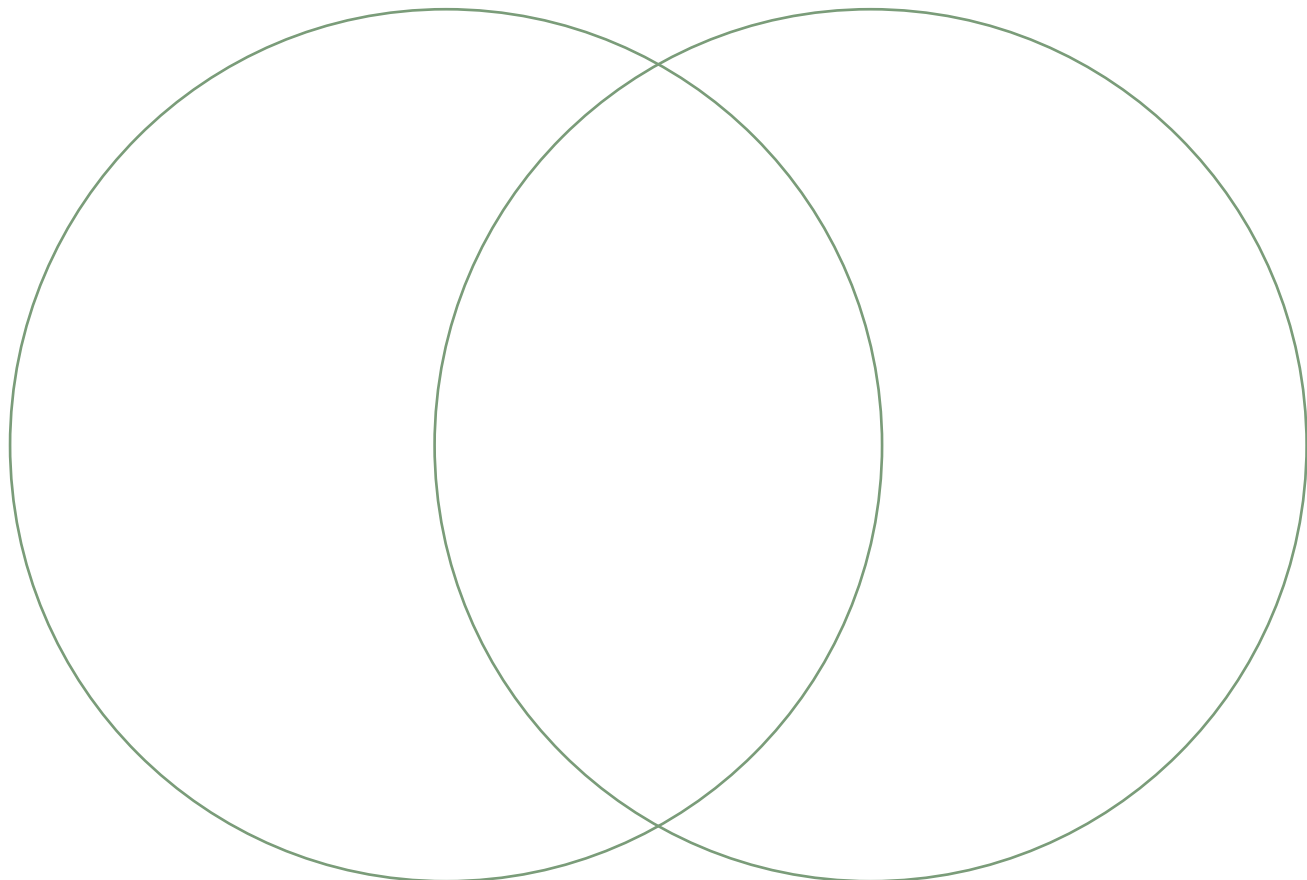

Using the words and phrases listed above, write a paragraph comparing and contrasting the two artworks.



The First Americans
Sid Richardson Museum

THE BLESSINGS OF THE BUFFALO

Some of the ways in which the Plains Indian used the buffalo are listed below:

BEARD:	decoration
BLADDER:	pouches, medicine bags
BLOOD:	soups, puddings, paint
BRAIN:	hide preparation, food
BONES:	pipes, knives, arrowheads, scrapers, paintbrushes, game dice, tableware, toys, jewelry
BUCKSKIN:	cradles, moccasin tops, winter robes, bedding, shirts, belts, leggings, dresses, quivers, tipi covers, tipi liners, bridles, dolls, mittens
BUFFALO CHIPS:	fuel
FAT:	tallow, soaps, hair grease
HAIR:	headdresses, pad fillers, pillows, ropes, bracelets, medicine balls, moccasin linings
HIND LEG SKIN:	presheped moccasin
HOOFS AND FEET:	glue, rattles
HORNS:	arrow points, cups, fire carrier, powder horn, spoons, headdresses, toys
LIVER:	tanning agents
MUSCLES:	glue, bows, thread, arrow-ties, cinches
RAWHIDE:	containers, shields, buckets, moccasin soles, drums, splints, ropes, saddles, saddle blankets, stirrups, bull boats, masks, parfleche, ornaments, capes, snowshoes
SKULL:	sun dance, medicine prayers
STOMACH LINER:	water containers, cooking vessels
TAIL:	medicine switch, fly brush, decorations, whips
TENDONS:	sinews for sewing, bowstrings
TONGUE:	choice meat, comb (rough side)
TEETH:	decoration

Source: American Bison Association



Student Activities

FAN POEM

Sit comfortably around a work of art. Discuss the possibility of looking at the artwork from different points of view.

Look closely at the artwork. Fold a piece of paper to resemble a fan and pass it to students, who will each write a line which they believe captures the essence of the artwork, or the meaning, from their point of view. Ask students to fold over their own response, so that the next student will not be able to read what they have written.

When everyone in the group is finished, read the poem, or ask a volunteer to read the poem. Discuss diverse or common points of view, based upon the visual cues in the artwork.

If the group is large, you may consider having participants write their responses on individual slips of paper, assembling comments as they are returned.



The First Americans
Sid Richardson Museum

DEAR...

Pretend you are a character in this painting. Write a letter home (to a friend or someone in your family). Write about what you see, what is happening, and how you feel. (Use the back of this page if you need more space).



Student Activities

PARFLECHE DIRECTIONS

Many Plains Indian groups used a parfleche, a rawhide carrying case, to hold objects such as dried food and clothing. The name is of French origin, and it was used as early as 1700 to mean rawhide articles. Parfleches ranged in size from one to three feet long and six to eighteen inches wide. Pocket-sized parfleches were also used. Sides, then the ends, were folded to make an envelope. Holes were punched into the rawhide and laced with hide strips to tie the ends together. Women usually decorated the cases with simple, geometric designs, using bright colors, such as red, black, yellow and green.

Materials: one large grocery bag (or 18 x 27" piece of butcher paper), pencil, crayons, and two pieces of string.

Tools: ruler, scissors, hole punch, and large needle.

Procedure:

1. Loosen glue seams and open grocery sack.
2. If desired, crumple sack to simulate leather appearance.
3. Measure sack as shown. (See figure A.) This parfleche is designed to hold standard 8 1/2 x 11" notebook paper.
Lightly sketch in the dotted lines on the bag.
4. With scissors, round out corners of the bag.
5. Fold bag along the dotted lines, folding in the overlapping "top" and "bottom" edges first.
6. Fold in sides to see parfleche take shape. Re-open the bag and flip it over on the table to draw a simple, geometric design on the outside. The design area will be outlined by the folds. (See Figure B.)
7. Color design with crayons. Press hard to get strong colors.
8. Punch holes in bag as indicated. (See Figures C & D.)
9. Lace one piece of string for each side, threading through overlapping holes to secure. (See Figure E.)

Source: Adapted from Irene Tejada, "Brown Bag Ideas: The Parfleche," **School Arts**, March 1985, 20-21.



The First Americans
Sid Richardson Museum

PARFLECHE DIRECTIONS

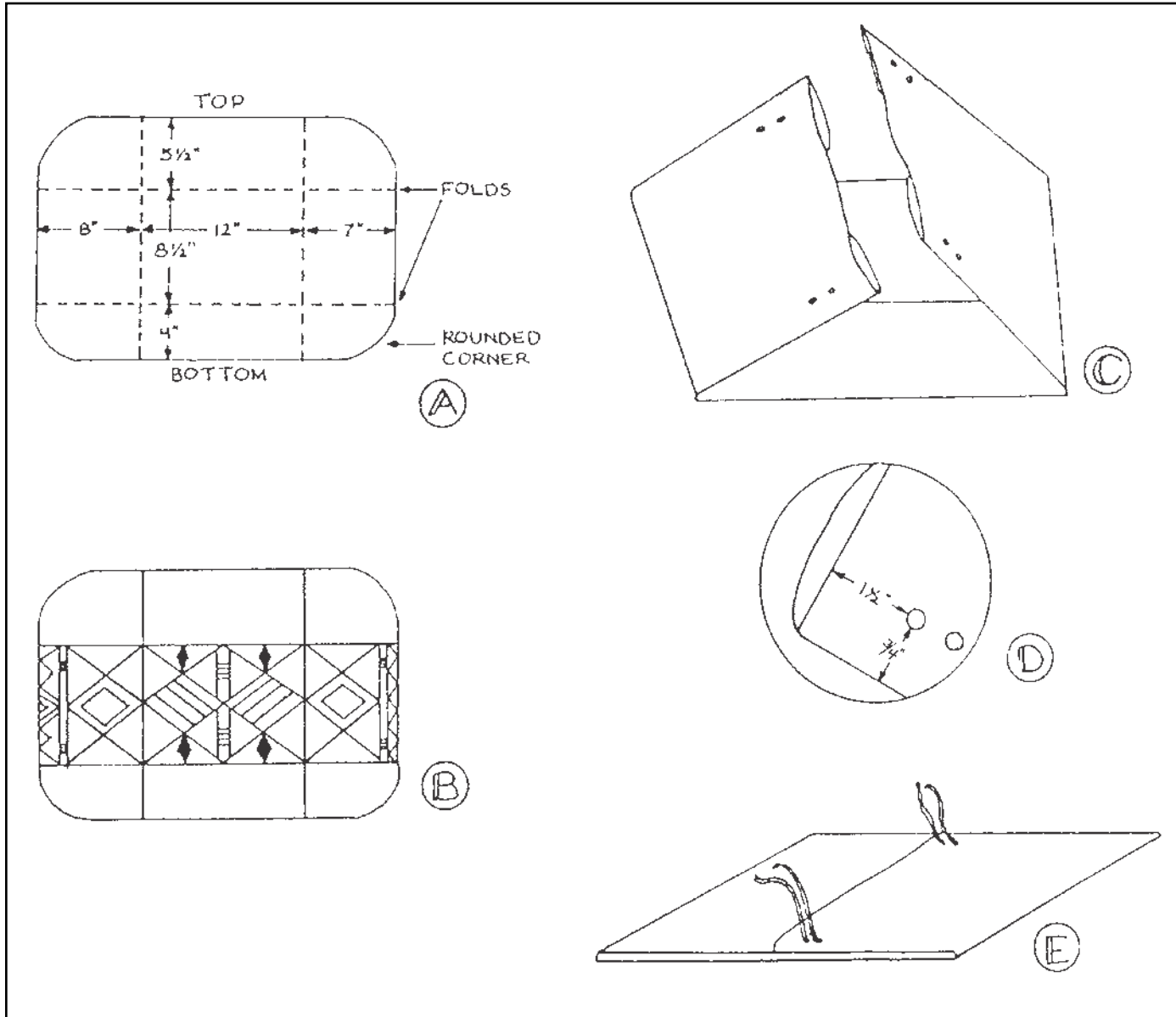

Source: Adapted from Irene Tejada, "Brown Bag Ideas: The Parfleche," *School Arts*, March 1985, 20-21.



Student Activities

TELLING A PAINTING'S STORY

STEP ONE: MAKE A LIST OF DETAILS

- Closely observe the painting.
- List every detail that you see in the work.
- List countable things in the work.
- List anything that is not in the picture, for example, anything that is hidden from your view.
- Do not include how you feel about the work. Do not include your reaction to the story in the painting.

STEP TWO: WRITE A SHORT DESCRIPTION

- Give information, using the list of details created in step one.
- Do not try to list all of the details. Choose the ones that are most important.
- Do not make any judgments about the painting.
- Write so that a reader could immediately recognize the work.

STEP THREE: WRITE A STORY ABOUT THE PAINTING

- Tell the story of the painting. Use your description to help you create your story.
- Think of the painting as a frame in a movie. “Unfreeze” the frame, and set the painting to motion.
- Write the story of either what is happening in the work, what has just happened, or what is going to happen.

From *Collecting Their Thoughts: Using Museums as Resources for Student Writing*, Smithsonian Institution Office of Elementary and Secondary Education, Washington, D.C., 1994.



The First Americans
Sid Richardson Museum

NAME THAT PAINTING

A narrative painting tells a story.

The painting's title often gives us a clue about what the artist thought was most important. It may tell us about the action, the setting, the character/s, why the action is taking place or the main idea.

Working with a partner, think up a title (a phrase that sums up the story) for this narrative painting. Write your title in the center of the frame below. Be ready to tell us how your title describes what is important about the painting.



Teacher Resources

WHY TEACH ART?

Why should art be a part of our students' education? The National Endowment for the Arts, in an attempt to summarize the variety of purposes for art education, has described four basic goals:

Civilization - Art provides students access to the achievements of our civilization and other civilizations, spread across vast distances of history and geography. Works of art of all civilizations help provide a basis for multicultural literacy, through which students may better understand not only themselves and their own heritage, but also that of the diverse peoples who share this world.

Creativity - Art fosters creativity, the ability to say and express thoughts, feelings, and values in visual form. Creativity is not simply the manipulation of art materials, but the purposeful exercise - using skills, technologies, and materials with which the student has become competent - of mind, heart, and hand in the translation of the student's private visions into public realities.

Communication - Art teaches effective communication and opens doors for students to an entire world of nonverbal forms of communication that carry powerful messages in our culture and others. The study of art's potential to communicate ideas, emotions, and values is fundamental to students' understanding of their world and their ability to function effectively within it.

Choice - Art teaches students to make choices based on critical assessment, not simply personal preference. It provides models that can help students learn to make critical choices and become discriminating consumers of the multitude of ideas and values that circulate in our culture. Art education nourishes the idea that life's important problems have more than one answer and that a variety of solutions may be created in response to any given problem.

Adapted from the National Endowment for the Arts.

VISUAL WARM-UPS

THREE CHANGES: Group leader asks for a volunteer, who will strike a pose for the group. Leader has the group turn away and makes three changes to the pose of the volunteer. Group turns back to face the volunteer and tries to guess the changes that were made. How does memory trick us?

TURN AROUND: Group is allowed one minute to study a painting, and then they must turn away to face the opposite wall. Students are asked to describe the features of the painting as completely as possible from memory. When group seems to be stumped, leader can allow another 30-second look. Leader can facilitate description by guiding students with such prompts as "Describe the background...middleground...foreground." How does repeated looking change one's perceptions? What parts are most memorable? Why?

SOUND SYMPHONY: Leader asks students to stand in front of a painting and name any object that might produce a sound or be associated with a sound. Student also recreates the named sound for the group. Leader divides group into sound sections (like an orchestra). After a "tune-up" practice, leader orchestrates different groups to produce their assigned sound loudly or softly upon directions and creates a group symphony of sounds related to the painting. How did participation change one's impression of the painting?

I PACKED MY BAG: Describe the scene in the painting. Tell students that they are going to "visit" this scene, and each one may take one object that would be useful in the context of the painting. Ask each student to name their object and explain how they will use it in the scene. Make up a story about the work of art and incorporate the objects. How do students' relationships with the artwork change?

JEOPARDY: Standing in front of an artwork, leader states the answers, and students generate the appropriate questions. Allow for diversity of questions that could yield the same answer. How did the challenge of finding questions differ from providing answers?



The First Americans
Sid Richardson Museum

VISUAL THINKING STRATEGIES Phillip Yenawine, Museum Educator

To facilitate discussions, teachers:

- ask open ended questions that are within the students' experiential and intellectual grasp, • validate the students' diverse responses, and • help link various parts of the conversation.

ASKING QUESTIONS

The following questions have been proven successful at stimulating lengthy and insightful discussions. They are easy for teachers to use regardless of their art background.

What's going on in this picture? or: • What is happening here? • What do we see here? • What about this picture?

What else can you find? or: • What more do you see? • Who can add to that? • Who sees something else? • Does anyone see something different?

What do you see that makes you say that? or: • How do you know that from the picture? • Where do you see that? • How can you tell?

Probing in order to open up discussion: • Can anyone add to that comment? • Who has another idea? • Does someone think something different? • Does everyone agree? • Does anyone disagree? What do you think instead?

RESPONDING TO COMMENTS

Responding supportively to students' comments is as important as asking questions. In order for students to feel confident that their opinions are valid, and to convince them that you are not searching for one "right answer", paraphrase each answer, as if you were saying, "What I hear you saying is..." If you aren't sure you got it right, ask for restatement.

Accept all interpretations as reasonable as long as they can be grounded in the students' observations--which is the purpose of the question: "What do you see that makes you say that?". You may not think all answers are correct, but let the group interaction sort the "truth" out. It usually does.

Acknowledge agreements and disagreements: "It seems that several people see that" or "we have a variety of opinions here."

RESPONDING TO QUESTIONS

If students ask questions, first respond by asking: "Can we answer that by examining the work?" If that fails, or does not seem to satisfy the questioner, continue with: "How might we find that answer?" You can check to see if the label supplies it, or determine what source might be the most useful as a reference text.



Teacher Resources

WEBSITES

Western Art Museums/Western Art Collections:

Autry National Center of the American West

<http://www.autrynationalcenter.org>

Located in Los Angeles, celebrates the American West through three institutions: the Museum of the American West, the Southwest Museum of the American Indian, and the Institute for the Study of the American West.

Buffalo Bill Historical Center

<http://www.bbhc.org/museums/>

Information on five museums located in Cody, WY, including the Buffalo Bill Museum, examining the life and historical context of W.F. "Buffalo Bill" Cody, The Whitney Gallery of Western Art, the Cody Firearms Museum, the Plains Indian Museum, and the Draper Museum of Natural History.

CM Russell Museum

<http://www.cmrussell.org>

Located in Great Falls, MT, the CMRM is dedicated to the life and art of CM Russell. The complex includes gallery space as well as Russell's log studio with artifacts he used for paintings, and his home that is furnished in period style.

Eiteljorg Museum of American Indians and Western Art

<http://www.eiteljorg.org>

The Eiteljorg is located in Indianapolis and includes both Native American and Western art. Collection includes Remington, Russell, and contemporary artists as well as Native American art and artifacts.

Frederic Remington Art Museum

<http://www.fredericremington.org>

A collection of Remington's paintings, bronzes and artifacts, located in Ogdensburg, NY. Museum also includes a re-creation of Remington's Connecticut studio and personal possessions from his home.

Gilcrease Museum

<http://www.gilcrease.org>

Museum located in Tulsa with over 10,000 drawings, paintings, prints, and sculptures from over 400 American artists from colonial to present day. Collection includes 18 of Remington's 22 bronzes.

Glenbow Museum

<http://www.glenbow.org>

Located in Calgary, Alberta in Canada, the Glenbow Museum archives and collects objects and documents relevant to northwest North America, specifically western Canada. Contains library, art collection and archives.

Heard Museum

<http://www.heard.org>

Located in Phoenix, AZ, the Heard is dedicated to educating the public about the cultures and arts of Native Americans, specifically in the Southwest. Museum programming includes annual festivals, art demonstrations and exhibitions.

The Museum of Western Art

<http://www.museumofwesternart.com>

This museum, which is located in Kerrville, TX, displays Western Art from late 19th century to present day, and artifacts of the American West. The museum also is host to traveling exhibitions.

National Cowboy and Western Heritage Museum

<http://www.nationalcowboymuseum.org>

Exhibits variety of western art, sculpture, artifacts, firearms, and Native American artifacts. Located in Oklahoma City, OK, the museum features the Prix de West art exhibition of contemporary western artists. Website includes Children's Site with activities, songs, games, and virtual tours of museum and the collection.



The First Americans
Sid Richardson Museum

National Museum of Wildlife Art

<http://www.wildlifeart.org>

Museum located in Jackson Hole, WY, exhibits fine art that is devoted to wildlife. Works date from 2000 B.C.E. to present, and focuses mainly on American and European painting and sculpture.

Norton Museum of Art

<http://www.norton.org>

The R.W. Norton Galleries include American and European painting and sculpture in Shreveport, LA. The R.W. Norton is particularly known for its collection of Remington and Russell paintings.

Rockwell Museum of Western Art

<http://www.rockwellmuseum.org>

A museum focused on Western and Native American art, located in Corning, New York.

Smithsonian American Art Museum

<http://www.americanart.si.edu>

Covers all aspects of American art, including colonial portraits, 19th c. landscapes, 20th c. realism, Western art, decorative art, African American art, Latino and folk art. Website includes online resources for teachers and students.

Woolaroc Museum & Wildlife Preserve

<http://www.woolaroc.org/>

Located in Bartlesville, OK, the Woolaroc has an assortment of art and artifacts by Western painters Remington, Russell, and Leigh, as well as firearms and even a 1927 aircraft. Also includes a Y-Indian Guide Center and Wildlife Preserve.

Fort Worth Art Museums:

Amon Carter Museum

<http://www.cartermuseum.org>

The Carter offers a survey of American art, from the early 19th – 20th centuries. Exhibits a large collection of Remingtons and Russells, as well as American artists Calder, Cole, Eakins, Homer, O’Keeffe, Sargent and Stieglitz.

Kimbell Art Museum

<http://www.kimbellart.org>

Exhibits pieces ranging from antiquities to 20th century, including masterpieces from Fra Angelico and Caravaggio to Cezanne and Matisse. Also houses Asian art collection and Mesoamerican, African, and Mediterranean pieces.

Modern Art Museum of Fort Worth

<http://www.mamfw.org>

The oldest art museum in Texas, with over 2,600 pieces, including post-war modern painting, sculpture, site-specific installations, prints, drawings, photos, and videotapes/discs.

Sid Richardson Museum

<http://www.sidrichardsonmuseum.org>

Located in Fort Worth, Texas, the museum exhibits a permanent collection of Western art by Frederic Remington, Charles Russell, and other late 19th c. American artists.

Website listing revised 7/1/2009



Teacher Resources

BIBLIOGRAPHY

- Anderson, Nancy K. *Frederic Remington: the Color of Night*. Washington DC: National Gallery of Art, 2003.
- Campbell, Suzan. *The American West: People, Places, and Ideas*. Corning: Rockwell Museum of Western Art, 2001.
- Dear, Elizabeth. *C.M. Russell's Log Studio*. Great Falls: C.M. Russell Museum, 1995.
- Dippie, Brian W., Ed. *Charles M. Russell, Word Painter: Letters 1887-1926*. New York: Harry N. Abrams, Inc., 1993.
- Dippie, Brian W. *Charlie Russell Roundup: Essays on America's Favorite Cowboy Artist*. Helena: Montana Historical Society Press, 1999.
- Dippie, Brian W. *Looking at Russell*. Fort Worth: Amon Carter Museum, 1987.
- Dippie, Brian W., Ed. *"Paper Talk" Charlie Russell's American West*. New York: Alfred A. Knopf Inc., 1979.
- Dippie, Brian. *Remington & Russell: The Sid Richardson Collection*. Austin: University of Texas Press, 1994.
- Dippie, Brian. *The Frederic Remington Art Museum Collection*. Frederic Remington Art Museum, 2001.
- Giesecke, Ernestine. *The Life and Work of Frederic Remington*. Chicago: Heinemann Library, 2000.*
- Greenbaum, Michael D. *Icons of the West: Frederic Remington's Sculpture*. Ogdensburg: Frederic Remington Art Museum, 1996.
- Hassrick, Peter H. *Charles M. Russell*. New York: Harry N. Abrams, Inc., 1989.
- Hassrick, Peter H. and Melissa J. Webster. *Frederic Remington: A Catalogue Raisonne of Paintings, Watercolors and Drawings, Volumes I and 2*. Cody: Buffalo Bill Historical Center, 1996.
- Hassrick, Peter H. *Remington, Russell and the Language of Western Art*. Washington, D.C.: Trust for Museum Exhibitions, 2000.
- Hassrick, Peter. *The Frederic Remington Studio*. Cody: Buffalo Bill Historical Center, 1994.
- Jennings, Kate F. *Remington and Russell and the Art of the American West*. Greenwich: Brompton Books Corporation, 1993.
- Neff, Emily Ballew with Wynne Phalen. *Frederic Remington: The Hogg Brothers Collection of the Museum of Fine Arts*. Houston: Princeton University Press, 2000.
- Newmann, Dana. *Plains Indians: A Complete Sourcebook*. West Nyack: The Center for Applied Research in Education, 1995.



The First Americans
Sid Richardson Museum

BIBLIOGRAPHY

Plain, Nancy. *Frederic Remington: Artist of the American West*. Berkeley Heights: Enslow Publishers, 2003.*

Samuels, Peggy and Harold. *Frederic Remington: A Biography*. Garden City: Doubleday and Company, 1982.

Samuels, Peggy and Harold. *Techniques of the Artists of the American West*. Secaucus: The Wellfleet Press, 1990.

Shapiro, Michael. *Cast and Recast: The Sculpture of Frederic Remington*. The Smithsonian Institution, 1981.

Shapiro, Michael. *Frederic Remington: The Masterworks*. Harry N. Abrams, Inc., 1988.

Shirley, Gayle C. *Charlie's Trail: The Life and Art of C. M. Russell*. Helena: Twodot/Falcon Press Publishing Co., Inc., 1996.*

Smith, Carter. *The Legendary Wild West, A Sourcebook on the American West*. Brookfield: The Millbrook Press, 1992.

Smith, Carter. *The Riches of the West, A Sourcebook on the American West*. Brookfield: The Millbrook Press, 1992.

Stewart, Rick. *Charles M. Russell, Sculptor*. Fort Worth: Amon Carter Museum, 1994.

Tejada, Irene. "Brown Bag Ideas: The Parfleche." *School Arts* (March 1985): 20-21.

The Henry Art Gallery. *Myth of the West*. Seattle: Henry Gallery Association, 1990.

Truettner, William H. *The West as America*. Washington: Smithsonian Institution Press, 1991.

Van Steenwyk, Elizabeth. *Frederic Remington*. New York: Franklin Watts, 1994.*

Venezia, Mike. *Frederic Remington (Getting to Know the World's Greatest Artists)*. New York: Children's Press, 2002.*

Warden, R.D. *C.M. Russell Boyhood Sketchbook*. Bozemon: Treasure Books, 1972.

Winter, Jeanette. *Cowboy Charlie*. San Diego: Harcourt Brace & Company, 1995.*

* Books for young people





C. Russell, *Returning to Camp* (detail) 1901



F. Remington, *The Thunder-Fighters...* (detail) 1892



F. Remington, *Apache Medicine Song* (detail) 1908